

PoolMatch

pH · ORP

INSTRUCTIONS MANUAL

EN

HANDBUCH

DE

MANUAL DE INSTALACION

ES

MANUEL D'INSTALLATION

FR

MANUALE D'INSTALLAZIONE

IT



WARNING!

Before carrying out ANY work inside control panel of the PoolMatch device, make sure you disconnect it from the power supply.

Failure to comply with the instructions contained in this manual could cause injury to people and/or damage to the appliance and the system.

1. PACKAGE CONTENT

| | | | | |
|-----------------------------------------------------------------------|--------------------------------------------|----------------------------------------------------|--------------------------------------------------------------|--------------------------------------------|
| A: Tapping saddle for securing PSS3 onto 2" hose (φ=50 mm) | B: Foot filter (PP riser) | C: Mounting bracket kit (φ=6 mm screws) | D: FPM Lip valve (3/8" GAS) | E: PSS3 probe-holder (1/2" GAS) |
| F: pH probe | G: Redox probe | H: pH 7 Buffer solution | I: pH 4 Buffer solution | J: 475 mV Calibration solution |
| K: Water | L: 4x6 (IDxOD mm) PVC tube (4m) | M: 4x6 (IDxOD mm) PE tube (5m) | N: Reducer for injection valve (1/2" M to 3/8" F) | |

| Item* | A | B | C | D | E | F | G | H | I | J | K | L | M | N |
|----------------------|---|---|---|---|---|---|---|---|---|---|---|---|---|---|
| System | | | | | | | | | | | | | | |
| PoolMatch pH | 2 | 1 | 1 | 1 | 1 | 1 | - | 1 | 1 | - | 1 | 1 | 1 | 1 |
| PoolMatch ORP | 2 | 1 | 1 | 1 | 1 | - | 1 | - | - | 1 | 1 | 1 | 1 | 1 |

* The values from the table represents the number of items inside the package.

PoolMatch | pH · ORP

WARNING!

These products are **DANGEROUS** and require special precautions during use, handling and storage.

- **NEVER mix chemical products.**
- NEVER allow children or people who have not read this manual to use or tamper with PoolMatch or any of its peripheral components (including chemical products).

pH chemical products:

- **ABSOLUTELY** not recommended => pure sulphuric acid
- Recommended for lowering pH => negative pH (with a sulphuric acid base)
- Recommended for raising pH => positive pH (sodium carbonate or bicarbonate)

ORP chemical products:

- **ABSOLUTELY** not recommended => all types of organic chlorine

The pH / ORP probes are subject to wear and tear and therefore are not covered by the warranty.

2. INSTALLATION INSTRUCTIONS

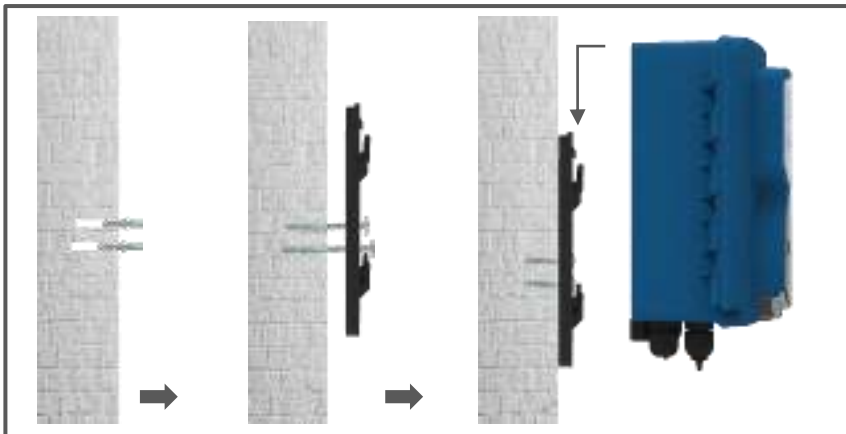

Make sure that the injection pressure is below 1.5 bar

Probe positioning

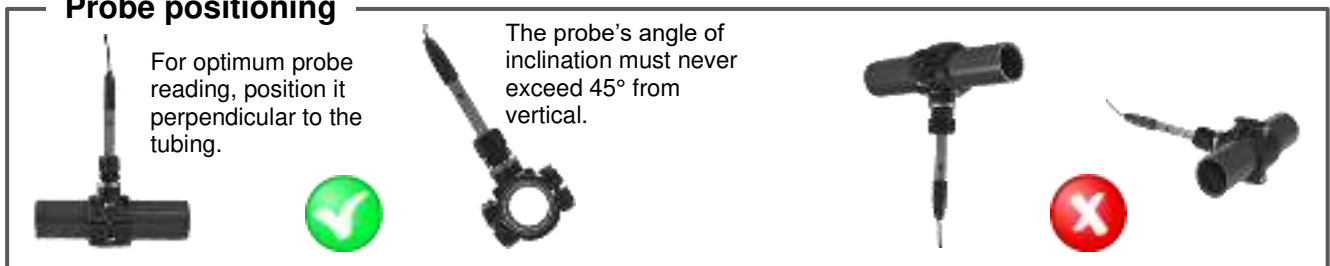

Installation plant

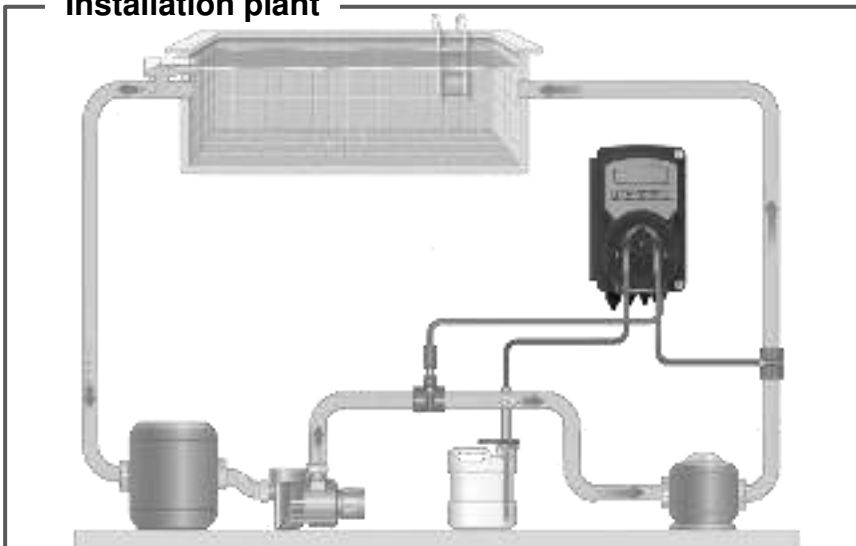

Warning!

Use with salt chlorinator:

For the pH systems, to prevent the risk of system malfunctioning or damage, observe the following instructions:

1. Position the pH measuring probe prior to the chlorinator cell.
2. To eliminate eddy currents, connect the pool water to an electrical ground point
3. Position the product injection point after the chlorinator cell.

3. ELECTRICAL CONNECTIONS

Connect the power supply cable to the mains and the servocontrol pre-wired cable to the auxiliary contact of the filter box (230 Vca).

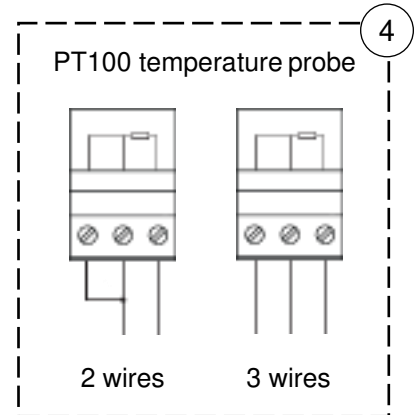
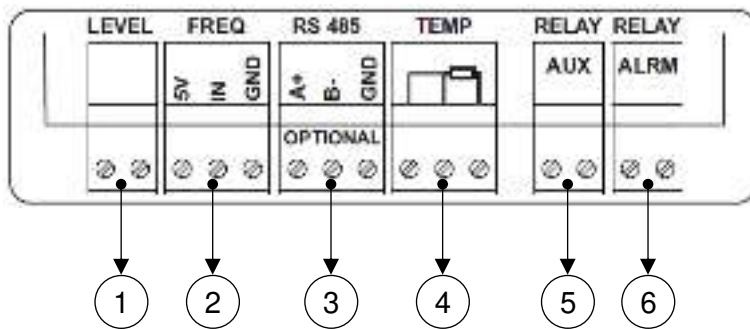

Wiring diagram:

1. Input Level Probe (Product Tank)
2. Input Frequency signal by Water meter pulse sender
3. RS485 Serial Port (optional)
4. Input Temperature Probe (PT100 sensor not included)
5. Output Relay Auxiliary Pump (Dry contact, Relay 250 Vac 10 A)
6. Output Relay Alarm remote (Dry contact, Relay 250 Vac 10 A)

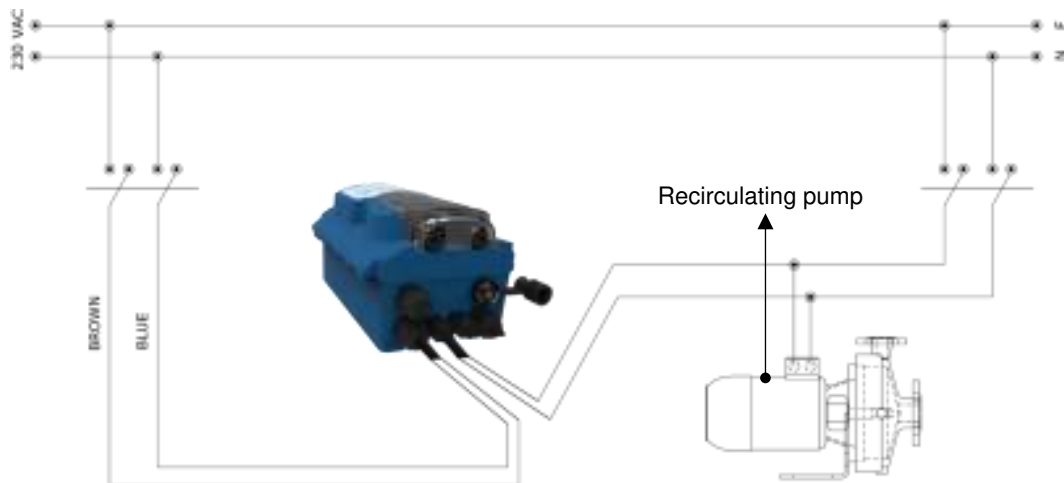

4. TECHNICAL SPECIFICATIONS

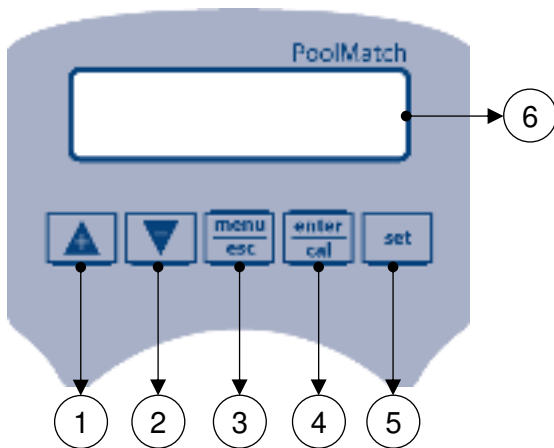

| Specifications | PoolMatch pH | PoolMatch ORP |
|-------------------------------|---------------------|---------------|
| Measure range | 3.0 ÷ 10.0 pH | 200 ÷ 999 mV |
| Set Point range | 6.0 ÷ 8.0 pH | 400 ÷ 850 mV |
| Alarm range | 5.0 ÷ 9.0 pH | 300 ÷ 900 mV |
| Accuracy | ± 0.04 pH | ± 2 mV |
| Resolution | 0.01 pH | 1 mV |
| Power supply | 230 VAC 50 Hz | |
| Insulation class | II | |
| Consumption | 10 W | |
| Pump flow rate | 1.6 l/h | |
| Max. back-pressure | 1.5 bar | |
| Probe calibration | Automatic | |
| Pump state | Proportional dosing | |
| Peristaltic tube (ID x OD mm) | Norprene 4.8 x 8 mm | |
| Dimensions (H x W x D mm) | 185 x 124 x 110 mm | |
| Weight | 1.0 kg | |

5. SETUP INSTRUCTIONS POOLMATCH SYSTEM



- 1) Button to increase the value
- 2) Button to decrease the value
- 3) Button Menu/Esc
- 4) Button Cal/OK
- 5) Button to set the setpoint
- 6) Digital display

Program Setup – Press  for 5 seconds

At the entry of each menu item, the parameter can be directly modified using the arrow keys ( and .

Confirmation of the current setting and switching to the next item is done by pressing the .

The menu has a circular structure: once you arrive at last item, the confirmation of the parameter set by pressing , determines the return to the first menu item.

1 **LANGUAGE** – It is possible to select between 5 available languages: **EN**, FR, IT, DE, ES

2 **SETPOINT** – **7.4pH** (5-9pH) / **700mV** (300-900mV)

3 **TYPE_DOSING** – **Acid** (Acid/Alka) / **Low** (Low/High)

4 **TIME_ON** = 30seconds (range from 1 to 360 seconds)

* Timed dosing only

5 **TIME_OFF** = 60seconds (range from 1 to 360 seconds)

4 **ADVANCED MENU**

4.1 **CIRCULATION PUMP** – (Enabled/disabled)

4.2 **TEMP. COMPESATION** – (Auto/Manual 25°C)

4.3 **OFR_OFF** – (0-60min.)

4.4 **RS485**

This menu is available only for models that have the RS485 Modbus connector

- Baud Rate (2400, 4800, 9600 or 19200)
- Polarity (Even, Odd or None)
- Address (from 1 to 240)
- RS485 Watchdog (Off, 1-30000 seconds)
- Watchdog Config (Hardware Reset, Watchdog Alarm, Stop Dosing, Reset Communication)

4.5 **INPUT FLOWRATE**

- Pulse/ liter 1:1
- Unit measure m³, l.

4.6 **CALIBRATION**



- Two points
- Single point
- Referece

4.7 **PERISTALTIC DOSING**

- On/Off
- Timed
- Prop
- Off

PoolMatch | pH · ORP





Save and exit Program setup – Press 

Pressing the  key determines the exit from the programming menu with saving of the parameters, if the parameter of the menu item in which one is in has not been changed when pressing the  key.



Set Point adjustment

Press the  button for 3 seconds, use  and  to set the desired value.

Stand-by mode (backlight on)

Press  and  buttons simultaneously for 5 seconds to switch off the unit backlight. Dosage and calibration are disabled. To exit standby, press  and  buttons simultaneously.



Priming

Only while the pump is in stand-by press down  and  in the same time.

Flowrate counter reset

To reset value of "Permanent Totalizer" press  button for 3 seconds, in stand-by mode only.

Offset/Slope Menu

Press  and  buttons the unit show Offset/Slope calibration value, press  or  to scroll the menu.

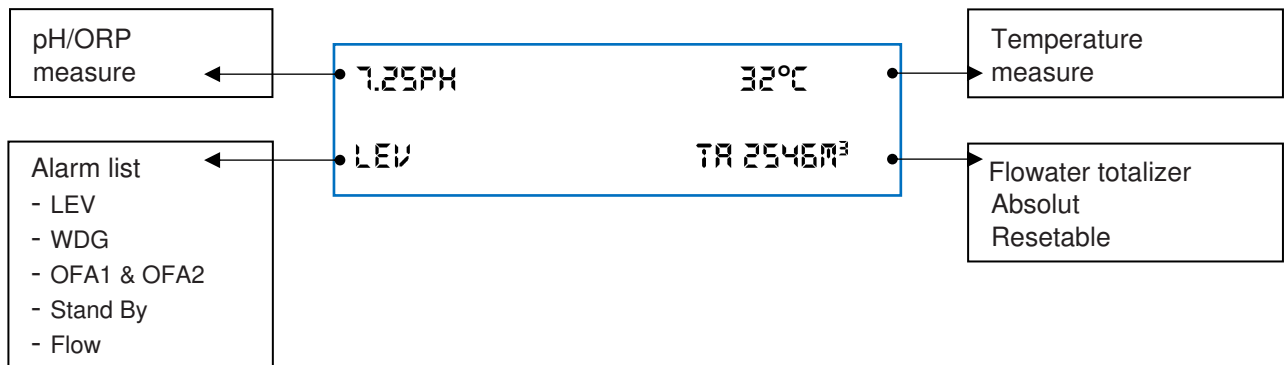

6. pH CALIBRATION

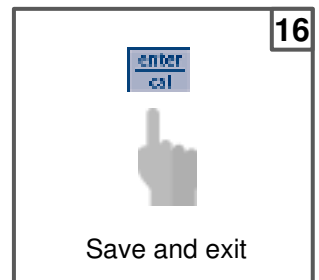
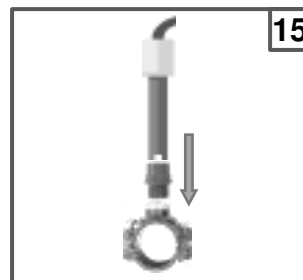
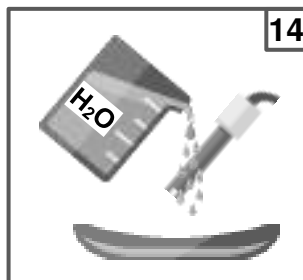
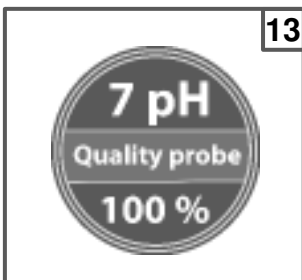
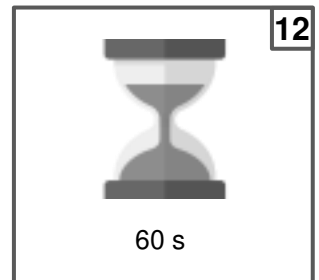
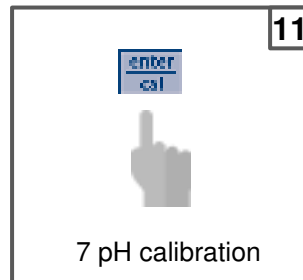
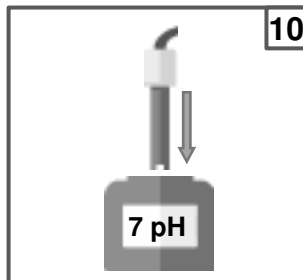
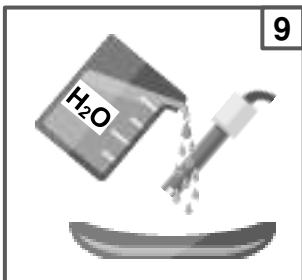
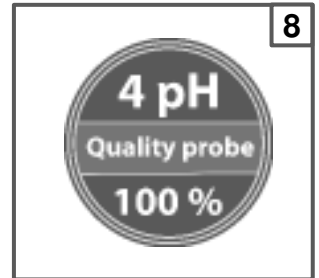
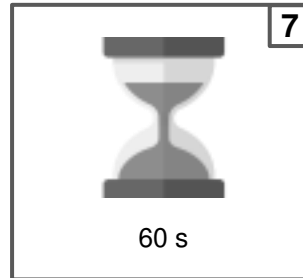
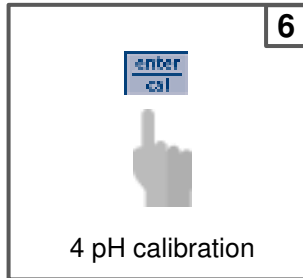
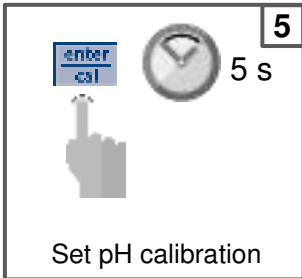
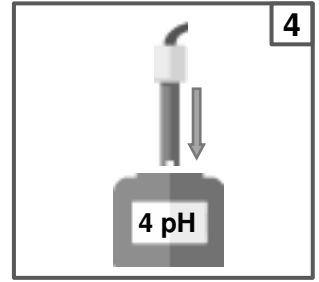
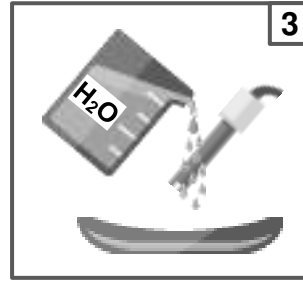
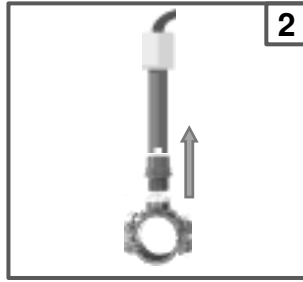
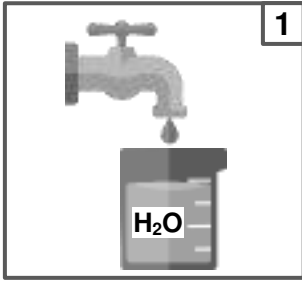

7. ORP CALIBRATION

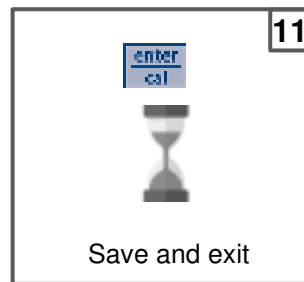
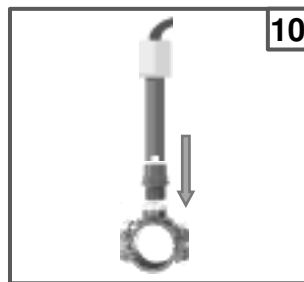
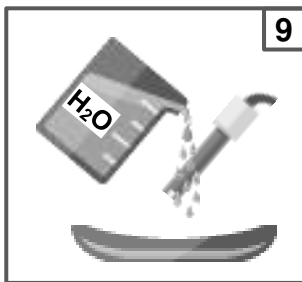
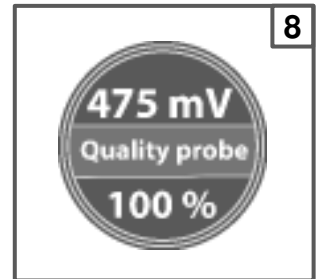
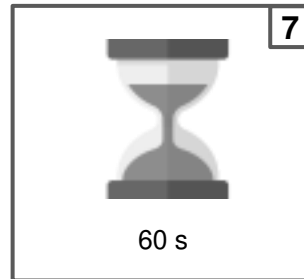
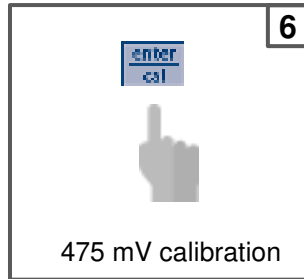
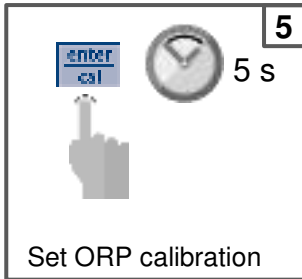
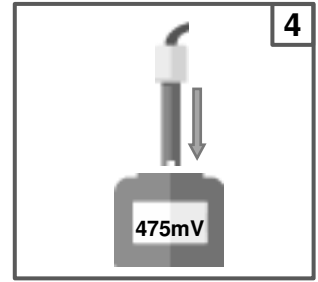
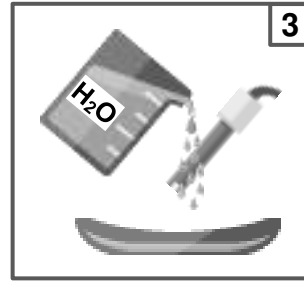
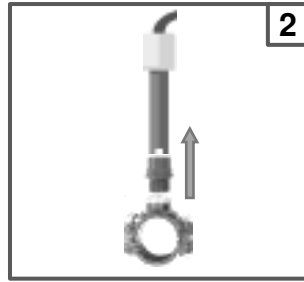
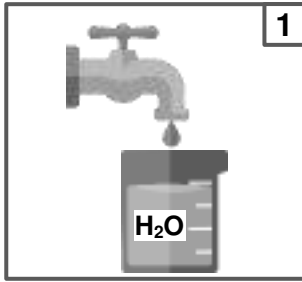

8. PROPORTIONAL DOSING

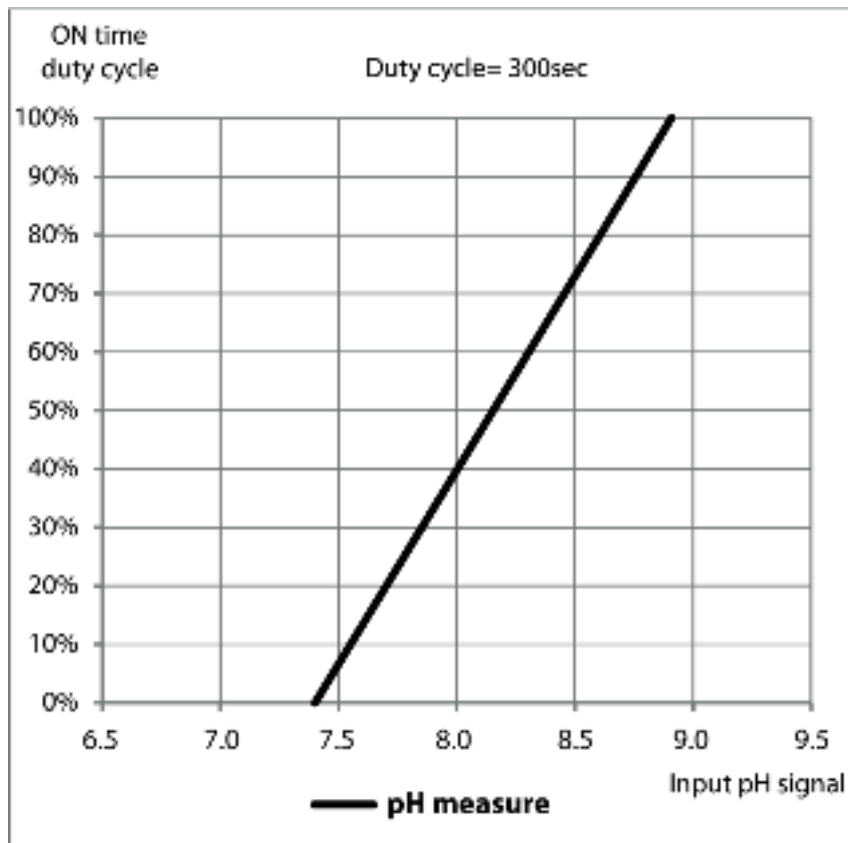

Setpoint = 7.4 pH
Dosing mode = Acid



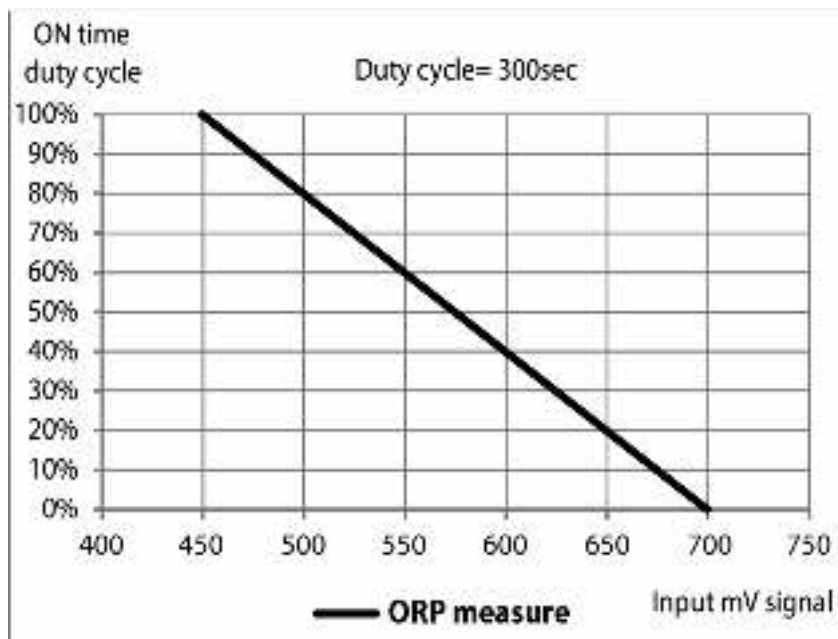



Setpoint = 700 mV
Dosing mode = Low



9. ALARMS

| Alarm | Display PoolMatch pH | Display PoolMatch ORP | Actions to do |
|-------------------------------|------------------------------------------------------|------------------------------|-------------------------------------------------------------------------------------------------------------------------------------------|
| Level | TANK LEVEL LOW | - | - Restore Product tank |
| Measure out of range | MEASURE TOO LOW (<5 pH) MEASURE TOO HIGH (>9pH) | MEASURE TOO LOW (<100 mV) | - Replace or check the measure probe - Restore pH / ORP measure |
| OFA Alarm (time >OFA time) | OFA | - | - Push  to reset |
| Flow Rate | FILTRATION OFF | - | - Restore Flow Rate |
| Calibration Function | ERROR_____4_PH ERROR_____7_PH CALIBRAT_____PH7 | ERROR_____700_MV | - Restore Probe or Buffer solution and repeat calibration procedure |
| System Error | PARAMETERS ERROR | | - Press  to restore Default parameter - Broken Unit |
| Modbus Error | MODS | | - Press  to reset - Restore communication |

To restore the default parameters, follow the steps below:

- Power off the PoolMatch unit
- Keep  and  pressed and power on the unit
- The unit will flash INIT.DEFAULT__NO
- Press  INIT.DEFAULT__YES
- Press  to restore the default parameters.

| Default Parameters | PoolMatch pH | PoolMatch ORP |
|--------------------|-----------------------|---------------|
| Language | EN | |
| Time OFA | OFF | |
| Flow Input | OFF | |
| Set Point value | 7.4 pH | 700 mV |
| Calibration | 7 pH / 4 pH (2-point) | 475 mV |
| Dosing Method | Acid | Low |

10. HANDLING

Hose replacement:



Open the pump's lid and release the hose by pulling the left connector upward.



Position the roller at 7h05, turning it in the direction of the circular arrow.



Completely release the left connector, holding it taut towards the outside, and turn the roller in the direction of the circular arrow so that the hose is freed up to the right connector.



Position the roller at 7h05, turning it in the direction of the circular arrow.



Insert the left connector into the relative housing and pass the hose under the roller's guide. Turn the roller in the direction of the circular arrow, simultaneously accompanying the hose into the pump's head, until the right connector is reached.



Close the pump's lid and press its surface hard so that it is properly locked into place.

















ACHTUNG!

Vor jeder Maßnahme innerhalb der Steuertafel des PoolMatch ist sicherzustellen, dass diese Vorrichtung vom Netz getrennt ist.

Die Nichteinhaltung der in dieser Anleitung enthaltenen Anweisungen kann zu Personenschäden, Schäden am Gerät und Schäden am System führen.

1. LIEFERUMFANG

| | | | | |
|--------------------------------------------------------------------------------------------------------------------------------------------------------------------------------------------|-----------------------------------------------------------------------------------------------------------------------------------|------------------------------------------------------------------------------------------------------------------------------------|------------------------------------------------------------------------------------------------------------------------------------------------------------------|--------------------------------------------------------------------------------------------------------------------------------|
|  A: Selbstschneidende Rohrschlauchklemme zum Befestigen des PSS3 auf dem 2"-Schlauch (φ=50 mm) |  B: Fußfilter (PP-Rohr) |  C: Halterungssatz (φ= 6 mm-Schrauben) |  D: FPM-Lippenventil (3/8" GAS) |  E: PSS3-Sondenträger (1/2" GAS) |
|  F: pH-Sonde |  G: Redox-Sonde |  H: Pufferlösung pH 7 |  I: Pufferlösung pH 4 |  J: Kalibrierlösung 475 mV |
|  K: Wasser |  L: 4x6 (IDxOD mm) PVC-Schlauch (4m) |  M: 4x6 (IDxOD mm) PE-Schlauch (5m) |  N: Reduzierstück für Einspritzventil (1/2" außen auf 3/8" innen) | |

| Artikel* | A | B | C | D | E | F | G | H | I | J | K | L | M | N |
|----------------------|---|---|---|---|---|---|---|---|---|---|---|---|---|---|
| PoolMatch pH | 2 | 1 | 1 | 1 | 1 | 1 | - | 1 | 1 | - | 1 | 1 | 1 | 1 |
| PoolMatch ORP | 2 | 1 | 1 | 1 | 1 | - | 1 | - | - | 1 | 1 | 1 | 1 | 1 |

* Die Zahlen in der Tabelle geben die Anzahl der jeweiligen Artikel im Lieferumfang an.

PoolMatch | pH · ORP

ACHTUNG!

Diese Produkte sind **GEFÄHRLICH** und der Umgang mit ihnen, der Gebrauch und die Lagerung erfordern besondere Vorsichtsmaßnahmen.

- **Chemikalien NIEMALS miteinander vermischen.**
- NIEMALS Kinder oder mit dieser Anleitung nicht vertraute Personen die Vorrichtung PoolMatch oder zugehörige Komponenten einschließlich der Chemikalien verwenden oder damit hantieren lassen.

pH-Werte der Chemikalien:

- **ABSOLUT** nicht empfohlen => reine Schwefelsäure
- Zum Senken des pH-Werts wird ein negativer pH-Wert empfohlen (auf der Grundlage von Schwefelsäure).
- Zum Erhöhen des pH-Werts wird ein positiver pH-Wert empfohlen (Natriumcarbonat oder Bicarbonat)

ORP-Werte der Chemikalien:

- **ABSOLUT** nicht empfohlen => Alle Arten organischer Chlorverbindungen

Alle pH- und ORP-Sonden sind **Verschleißteile** und daher von jeglicher Garantie ausgeschlossen.

2. EINBAUANLEITUNG

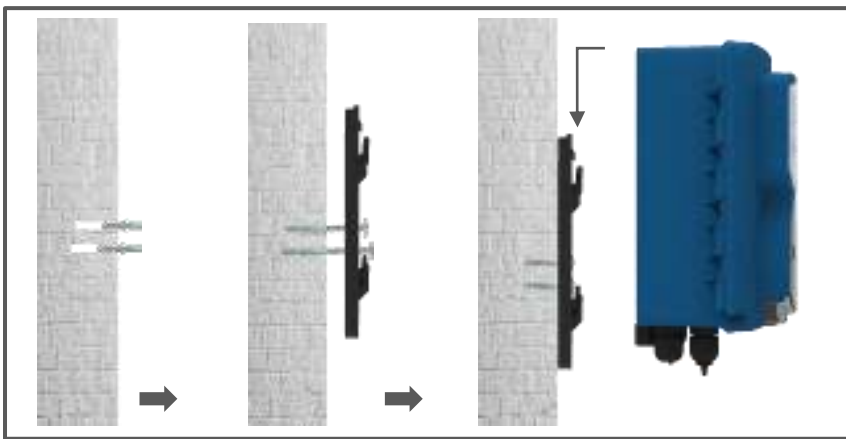

Vergewissern Sie sich, dass der Einspritzdruck weniger als 1,5 bar beträgt

Positionierung der Messsonde

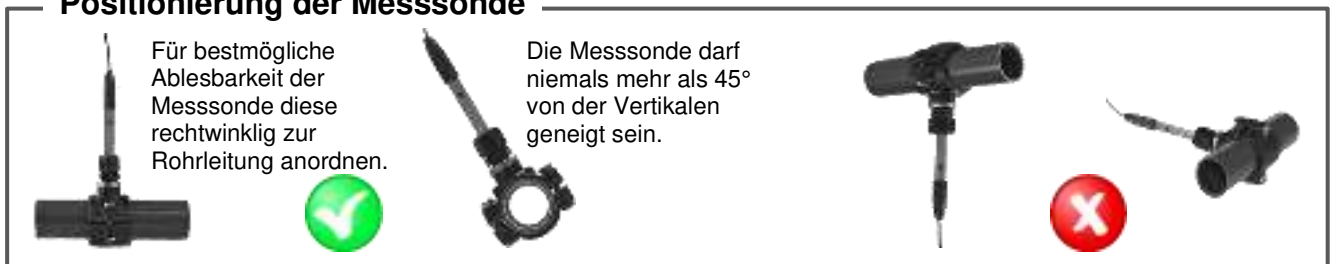

Anlagenaufbau

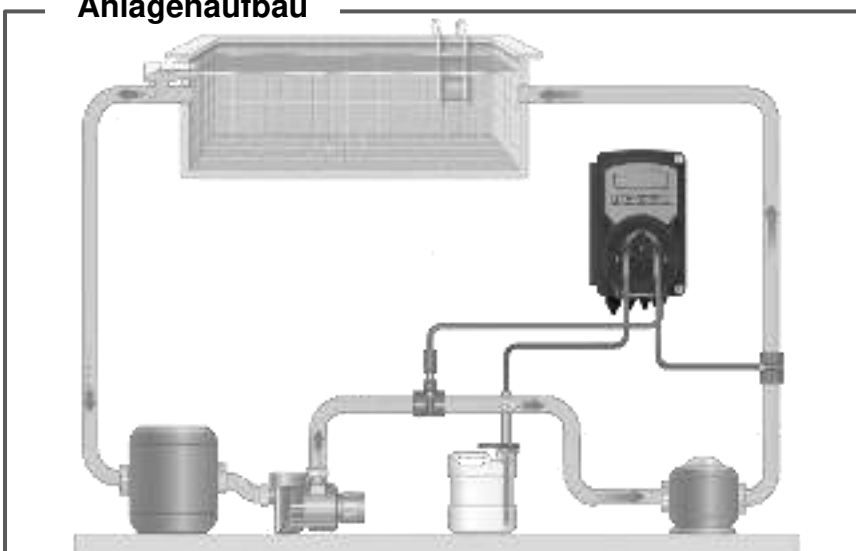

Achtung!

Verwendung mit Salzchlorungsmittel:

Um bei pH-Systemen Systemstörungen und Systemschäden vorzubeugen, ist Folgendes zu beachten:

1. Die pH-Messsonde vor der Chlorierungszelle positionieren.
2. Zur Vermeidung von Fehlerströmen das Poolwasser erden.
3. Den Einspritzpunkt für das Mittel hinter der Chlorierungszelle positionieren.

3. ELEKTRISCHE ANSCHLÜSSE

Das Netzstromkabel an das Netz und das vorgefertigte Servo-Steuerungskabel an den Hilfskontakt der Filterbox (230 Vca) anschließen.

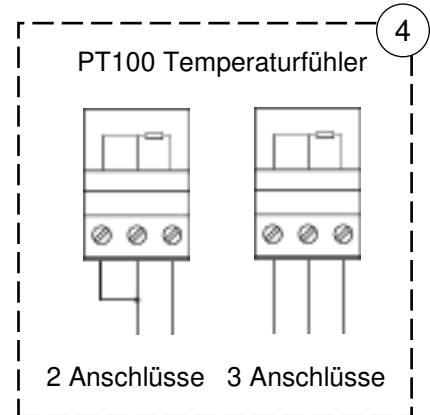
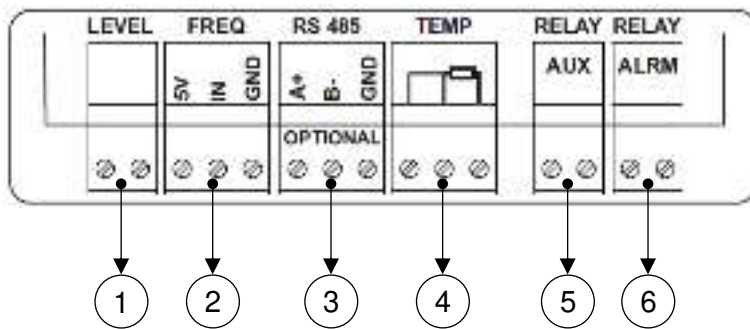

Schaltplan:

1. Eingang Füllstandsonde (Mittelbehälter)
2. Eingangsfrequenzsignal vom Impulsgeber des Wasserzählers
3. RS485 Serieller Port (optional)
4. Eingang Temperaturfühler (PT100 Temperaturfühler)
5. Ausgangsrelais Hilfspumpe (Trockenkontakt, Relais 250 Vac 10 A)
6. Ausgang Fernalarmrelais (Trockenkontakt, Relais 250 Vac 10 A)

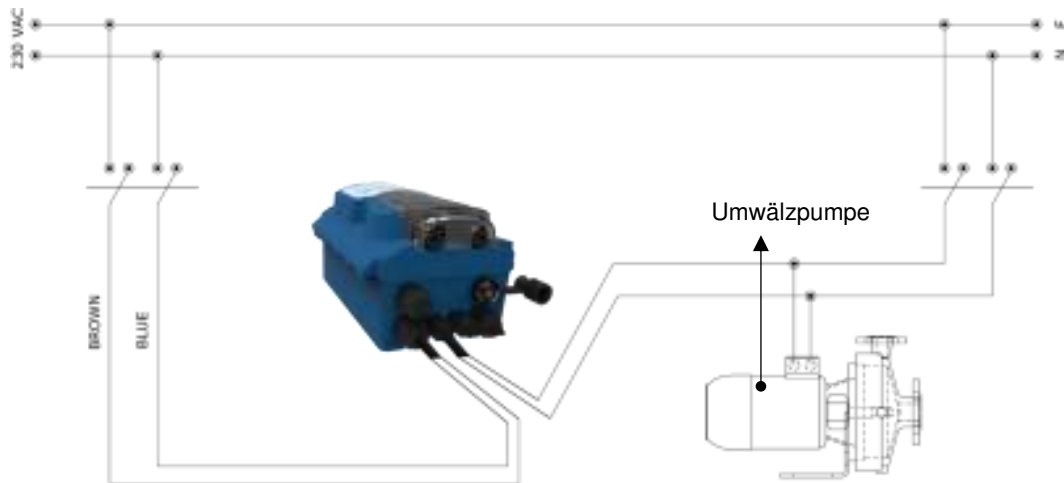

4. TECHNISCHE DATEN

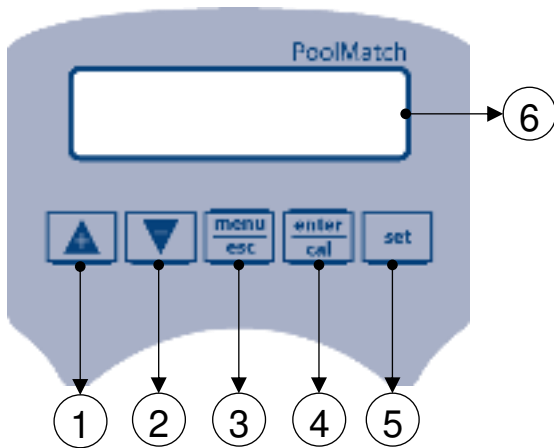

| Daten | PoolMatch pH | PoolMatch ORP |
|-----------------------------------|-------------------------|---------------|
| Messbereich | 3,0 ÷ 10,0 pH | 200 ÷ 999 mV |
| Sollwertbereich | 6,0 ÷ 8,0 pH | 400 ÷ 850 mV |
| Alarmbereich | 5,0 ÷ 9,0 pH | 300 ÷ 900 mV |
| Genauigkeit | ± 0,04 pH | ± 2 mV |
| Genauigkeit des Geräts | 0,1 pH | 1 mV |
| Stromversorgung | 230 VAC, 50 Hz | |
| Schutzklasse | II | |
| Verbrauch | 10 W | |
| Durchfluss Pumpe | 1,6 l/h | |
| Max. Gegendruck | 1,5 bar | |
| Sondenkalibrierung | Automatisch | |
| Pumpenstatus | Proportionale Dosierung | |
| Peristaltik-Schlauch (ID x OD mm) | Norprene 4,8 x 8 mm | |
| Abmessungen (H x B x T mm) | 185 x 124 x 110 mm | |
| Gewicht | 1,0 kg | |

5. SETUP-ANLEITUNGEN POOLMATCH-SYSTEM



- 1) Taste zur Erhöhung des Wertes
- 2) Taste zum Verringern des Wertes
- 3) Taste Menü/Esc
- 4) Taste Cal/OK
- 5) Taste zum Einstellen des Sollwerts
- 6) Digitalanzeige

Programm-Einstellung - 5 Sekunden  lang gedrückt halten

Bei der Eingabe jedes Menüpunktes kann der Parameter direkt mit den Pfeiltasten geändert werden ( und ). Die Bestätigung der aktuellen Einstellung und das Umschalten zum nächsten Punkt erfolgen durch Drücken der Taste .

Das Menü ist kreisförmig aufgebaut: Wenn Sie den letzten Punkt erreicht haben, bestimmt die Bestätigung der Parametereinstellung durch Drücken von  die Rückkehr zum ersten Menüpunkt.

- 1 **SPRACHE**: - Es stehen fünf Sprachen zur Verfügung, aus denen gewählt werden kann: **EN**, FR, IT, DE, ES
- 2 **SOLLWERT** – 7.4 pH (5-9 pH) / 700 mV (300-900 mV)
- 3 **ART_DOSIERUNG** – **Säure** (Sauer/Alka) / **Niedrig** (Niedrig/Hoch)
- 4 **ZEIT_AN** = 30 Sekunden (Bereich von 1 bis 360 Sekunden)
- 5 **ZEIT_AUS** = 60 Sekunden (Bereich von 1 bis 360 Sekunden)

* Nur zeitgesteuerte Dosierung

4 ERWEITERTES MENÜ

- 4.1 **UMWALZPUMPE** - (aktiviert/deaktiviert)
- 4.2 **TEMP. KOMPENSATION** - (Auto/Manuell 25°C)
- 4.3 **OFR_AUS** – (0-60Min.)
- 4.4 **RS485**

Dieses Menü ist nur für Modelle mit RS485-Modbus-Anschluss verfügbar

- Baudrate (2400, 4800, 9600 oder 19200)
- Polarität (Gerade, Ungerade oder Keine)
- Adresse (von 1 bis 240)
- RS485-Watchdog (Aus, 1-30000 Sekunden)
- Watchdog-Config (Hardware-Reset, Watchdog-Alarm, Dosierung stoppen, Kommunikation zurücksetzen)

4.5 EINGANG DURCHFLUSSMENGE

- Impuls/Liter 1:1
- Einheit Messung m³, l.

4.6 KALIBRIERUNG



- Zwei Punkte
- Einfachpumpe
- Bezug

4.7 SCHLAUCHDOSIERUNG

- On/Off (Ein/Aus)
- Zeitgesteuert
- Prop

PoolMatch | pH · ORP





Off/AusSpeichern und Programm verlassen -  drücken

Durch Drücken der Taste  wird das Programmiermenü mit Speichern der Parameter verlassen, wenn der Parameter des Menüpunktes, in dem man sich befindet, beim Drücken der Taste nicht geändert wurde .

Sollwerteneinstellung

Die  -Taste 3 Sekunden lang drücken,  und  verwenden, um den gewünschten Wert einzustellen.

Standby-Modus (Hintergrundbeleuchtung an)

Die Tasten  und  gleichzeitig 5 Sekunden lang drücken, um die Hintergrundbeleuchtung des Geräts auszuschalten. Dosierung und Kalibrierung sind deaktiviert. Um den Bereitschaftszustand zu verlassen, die Tasten  und  gleichzeitig drücken.





Vorbereitung

Mit in Stand-by befindlicher Pumpe  und  gleichzeitig nach unten drücken.

Durchflussmengenzähler Reset

Um den Wert des „Permanentzählers“ zurückzusetzen, drücken Sie die  Taste 3 Sekunden lang, nur im Standby-Modus.

Offset/Slope (Neigungs)-Menü

Drücken Sie die Tasten  und , bis das Gerät den Wert für die Offset-/Slopekalibrierung anzeigt. Drücken Sie  oder , um durch das Menü zu scrollen.

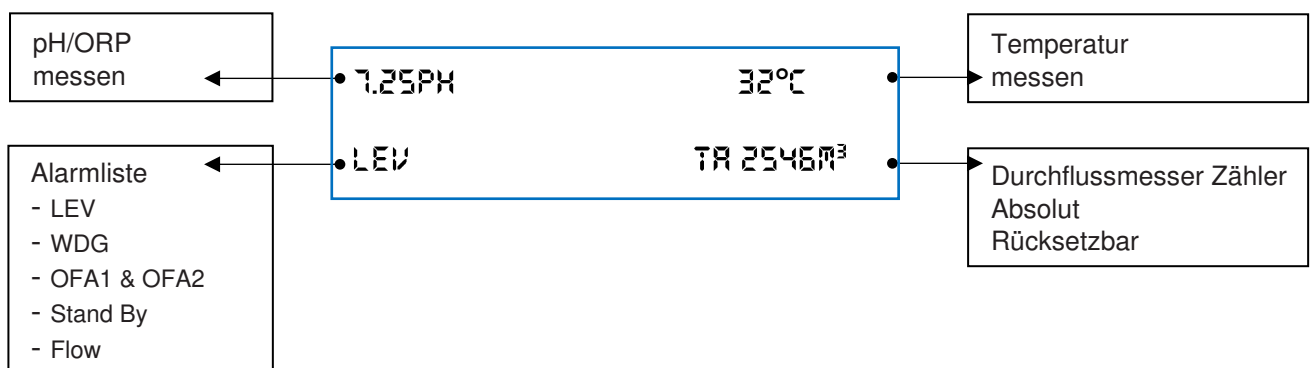

6. pH-KALIBRIERUNG

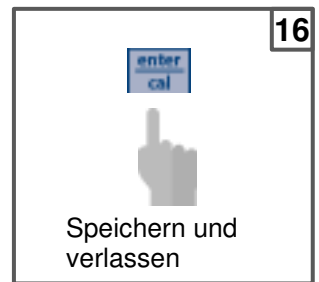
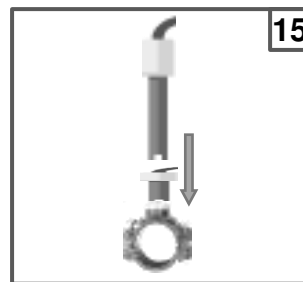
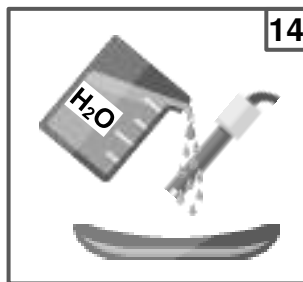
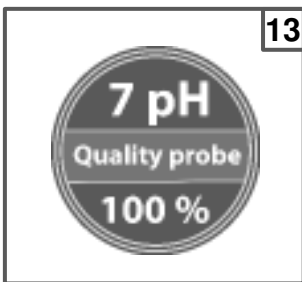
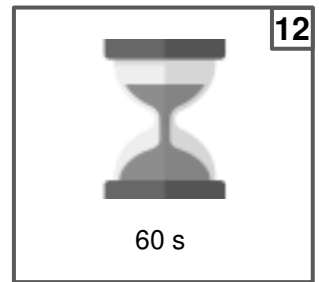
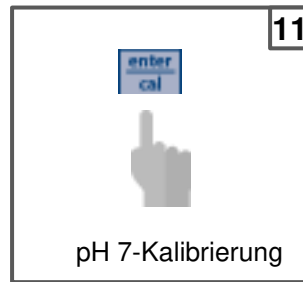
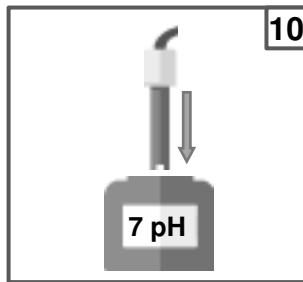
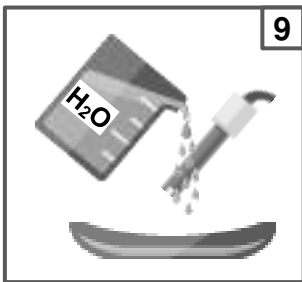
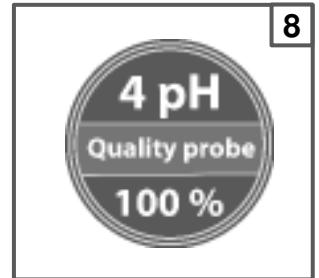
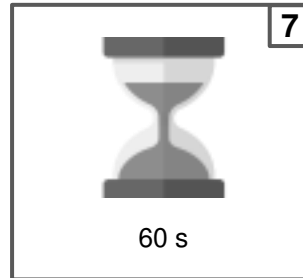
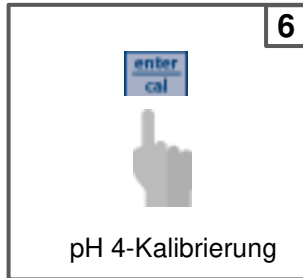
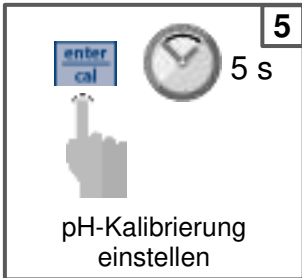
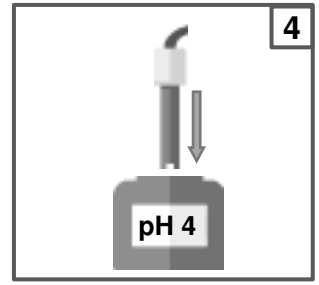
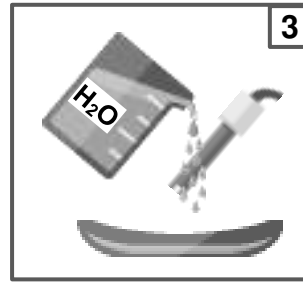
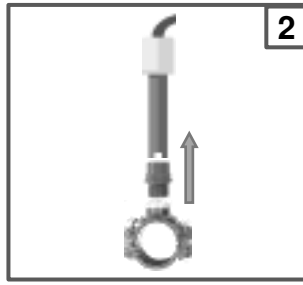
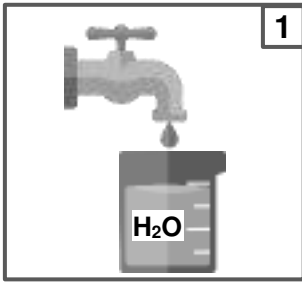

7. ORP-KALIBRIERUNG

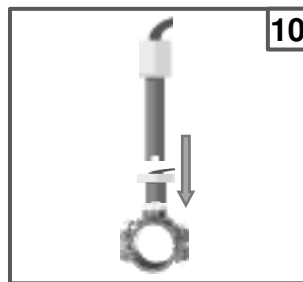
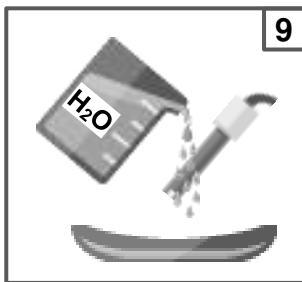
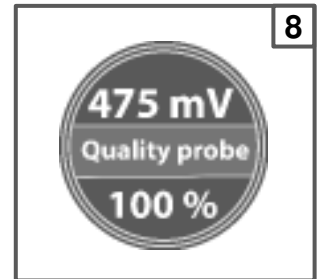
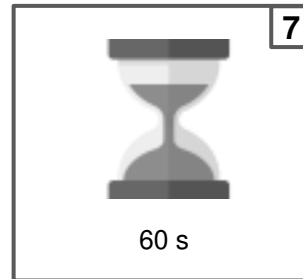
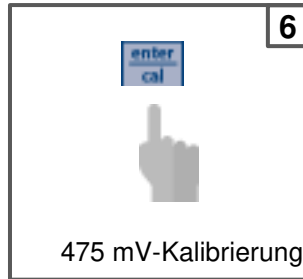
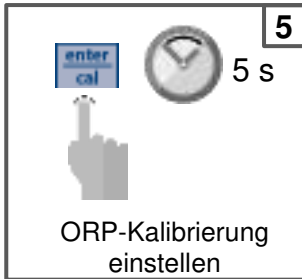
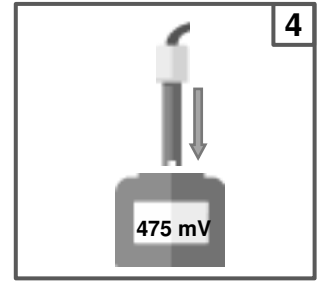
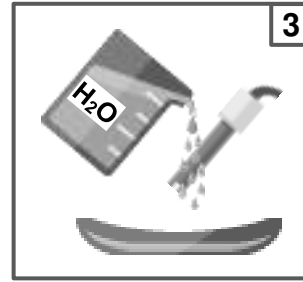
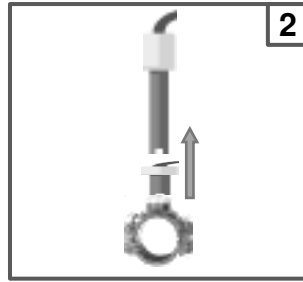
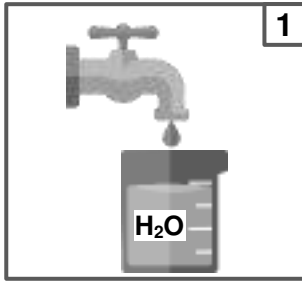

8. PROPORTIONALE DOSIERUNG

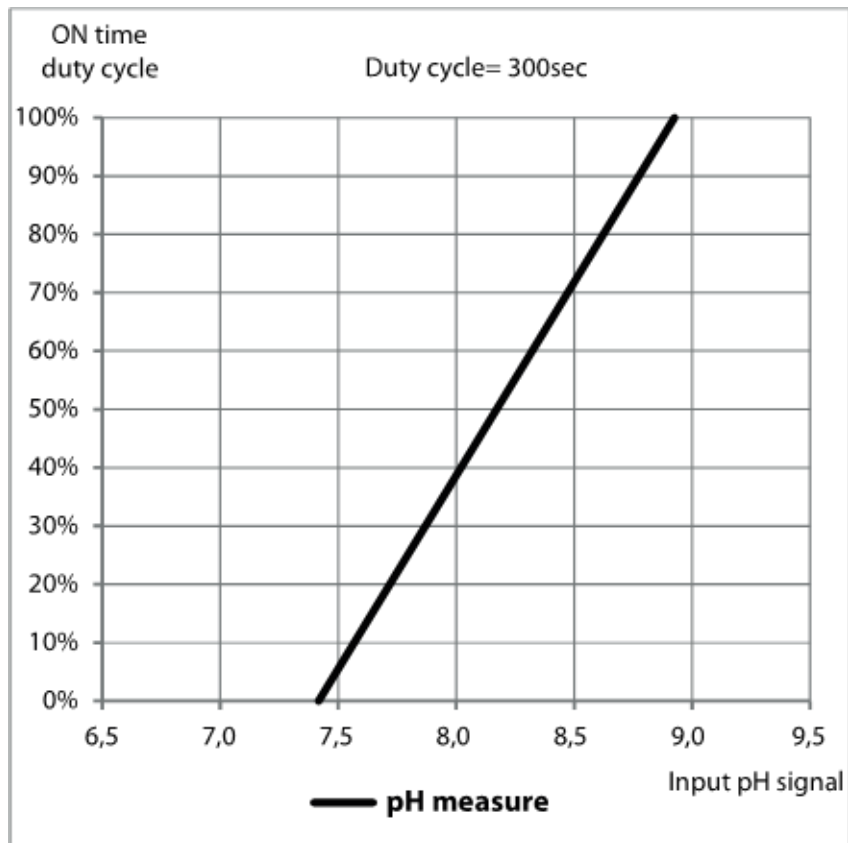

Sollwert = 7,4 pH
Dosiermodus = Säure



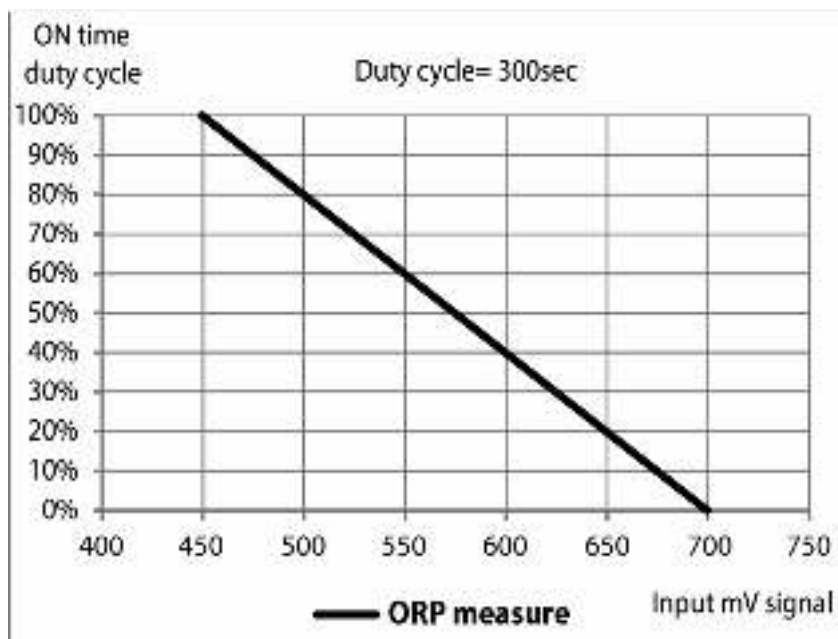



Sollwert = 700 mV
Dosiermodus = Niedrig



9. ALARME

| Alarm | Display PoolMatch pH | Display PoolMatch ORP | Maßnahmen |
|-------------------------------------------|---------------------------------------------------------|------------------------------|----------------------------------------------------------------------------------------------------------------------------------------------------------|
| Füllstand | TANK FULLSTAND NIEDRIG | - | - Produktbehälter zurücksetzen |
| Messung außerhalb des zulässigen Bereichs | MESSUNG ZU NIEDRIG (<5 pH) MESSUNG ZU HOCH (>9pH) | MESSUNG ZU NIEDRIG (<100 mV) | - Den Messfühler prüfen, ggf. ersetzen - pH-/ORP-Messgröße wiederherstellen |
| OFA-Alarm (Zeit > OFA-Zeit) | OFA | - | - Zum Zurücksetzen  drücken |
| Durchfluss | FILTRATION AUS | - | - Durchfluss wiederherstellen |
| Kalibrierfunktion | FEHLER_____7_PH FEHLER_____4_PH KALIBRIER_____PH7 | FEHLER_____700_mV | - Sonde oder Pufferlösung ersetzen und neu kalibrieren |
| Systemfehler | PARAMETERFEHLER | | -  drücken, um zum Standardparameter zurückzukehren - Gerät defekt |
| Modbus-Fehler | MODS | | - Zum Zurücksetzen  drücken - Kommunikation wiederherstellen |

Um zur Standardeinstellung zurückzukehren, wie folgt vorgehen:

- Die PoolMatch -Einheit ausschalten
-  und  gedrückt halten und Strom wieder einschalten
- Das Gerät blinkt mit INIT.DEFAULT__NEIN
-  INIT.DEFAULT__JA drücken
-  drücken, um die Standardparameter wiederherzustellen.

| Standardeinstellung | PoolMatch pH | PoolMatch ORP |
|---------------------|-----------------------|---------------|
| Sprache | EN | |
| OFA-Zeit | AUS | |
| Durchflusseingang | AUS | |
| Sollwert | pH 7,4 | 700 mV |
| Kalibrierung | 7 pH / 4 pH (2-Punkt) | 475 mV |
| Dosierverfahren | Säure | Niedrig |

10. HANDHABUNG

Ersetzen der Schläuche:



Den Pumpendeckel öffnen und den Schlauch durch Hochziehen des linken Anschlusses freigeben.



Den Rotor auf 7:05 Uhr stellen, dazu in Richtung des kreisförmigen Pfeils drehen.



Den linken Anschluss vollständig freigeben und dabei leicht nach außen ziehen und den Läufer in Richtung des kreisförmigen Pfeils drehen, so dass der Schlauch am rechten Anschluss freigegeben wird.



Den Läufer auf 7:05 Uhr stellen, dazu in Richtung des kreisförmigen Pfeils drehen.



Den linken Anschluss in sein Gehäuse schieben und den Schlauch unter der Läuferführung durchschieben. Den Läufer in Richtung des kreisförmigen Pfeils drehen und dabei gleichzeitig den Schlauch in den Pumpenkopf einführen, bis der rechte Anschluss erreicht wird.



Den Pumpendeckel schließen und fest auf seine Oberfläche drücken, so dass er richtig einrastet.

















¡ADVERTENCIA!

Antes de llevar a cabo CUALQUIER TIPO de trabajo en el interior del panel de control del dispositivo PoolMatch, asegúrese de desconectarlo de la fuente de alimentación.

El incumplimiento de las instrucciones recogidas en el presente manual puede ocasionar lesiones a las personas y/o daños al aparato y al sistema.

1. CONTENIDO DEL EMBALAJE

| | | | | |
|-------------------------------------------------------------------------------------|-------------------------------------------------------------------------------------|-------------------------------------------------------------------------------------|---------------------------------------------------------------------------------------|---------------------------------------------------------------------------------------|
|  |  |  |  |  |
| A: Montura de conexión para asegurar PSS3 en la manguera de 2" (φ=50 mm) | B: Filtro de fondo (elevador de PP) | C: Kit del soporte de montaje (φ= tornillos de 6 mm) | D: Válvula labial FPM (3/8" GAS) | E: Soporte de sonda PSS3 (1/2" GAS) |
|  |  |  |  |  |
| F: Sonda pH | G: Sonda Redox | H: Solución tampón pH 7 | I: Solución tampón pH 4 | J: Solución de calibración 475 mV |
|  |  |  |  | |
| K: Agua | L: Tubo PVC 4x6 (IDxOD mm) (4m) | M: Tubo PE 4x6 (IDxOD mm) (5m) | N: Reductor para válvula de inyección (1/2" M hasta 3/8" F) | |

| Elemento* | A | B | C | D | E | F | G | H | I | J | K | L | M | N |
|----------------------|---|---|---|---|---|---|---|---|---|---|---|---|---|---|
| Sistema | | | | | | | | | | | | | | |
| PoolMatch pH | 2 | 1 | 1 | 1 | 1 | 1 | - | 1 | 1 | - | 1 | 1 | 1 | 1 |
| PoolMatch ORP | 2 | 1 | 1 | 1 | 1 | - | 1 | - | - | 1 | 1 | 1 | 1 | 1 |

* Los valores de la tabla representan el número de elementos que se encuentran dentro del paquete.

¡ADVERTENCIA!

Estos productos son **PELIGROSOS** y requieren precauciones especiales durante su uso, manipulación y almacenamiento.

- **No mezcle NUNCA productos químicos.**
- No permita NUNCA que niños o personas que no hayan leído este manual usen o manipulen PoolMatch o alguno de sus componentes periféricos (incluidos los productos químicos).

Productos químicos de pH:

- No recomendado **EN ABSOLUTO** => ácido sulfúrico puro
- Recomendado para reducir el pH => pH negativo (con una base de ácido sulfúrico)
- Recomendado para aumentar el pH => pH positivo (carbonato de sodio o bicarbonato)

Productos químicos ORP:

- No recomendado **EN ABSOLUTO** => cualquier tipo de cloro orgánico

Las sondas de pH/ORP están sujetas a desgaste y deterioro, por lo que no están cubiertas por la garantía.

2. INSTRUCCIONES DE INSTALACIÓN

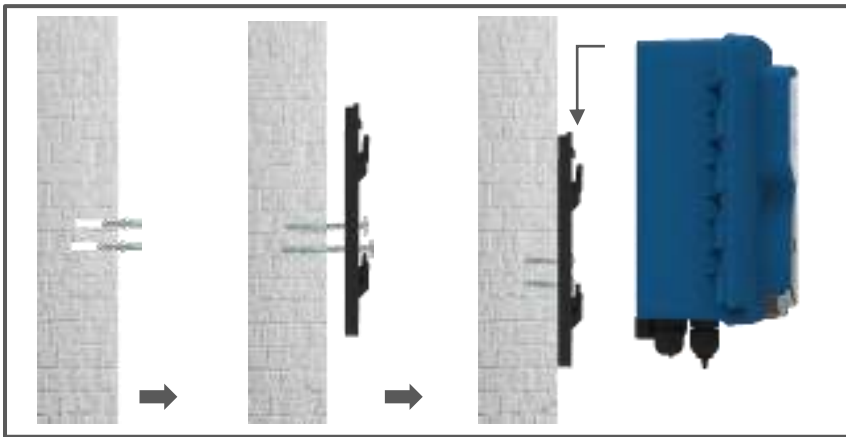

Asegúrese de que la presión de inyección está por debajo de 1,5 bares

Colocación de la sonda

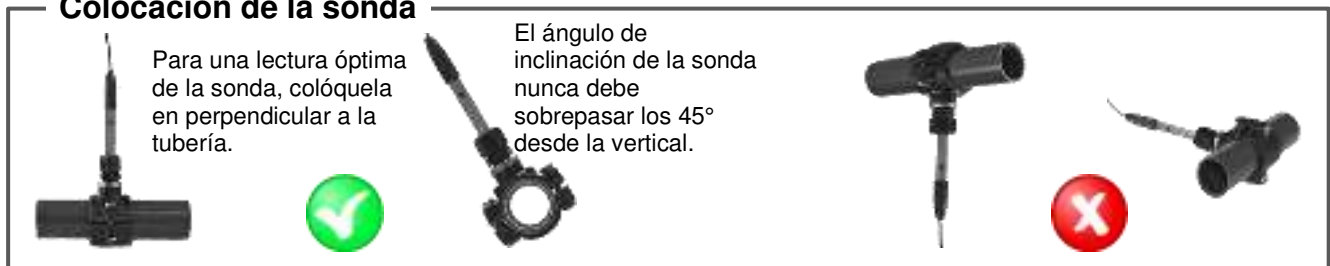

Planta de instalación

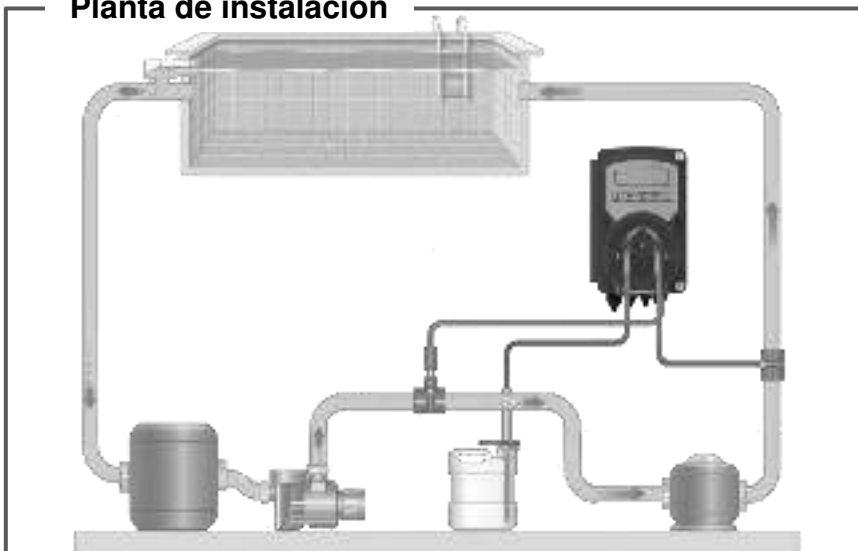

¡Advertencia!

Usar con clorador salino:

En los sistemas de pH, para evitar el riesgo de que el sistema funcione incorrectamente o se dañe, respete las siguientes instrucciones:

1. Coloque la sonda de medición de pH antes de la célula del clorador.
2. Para eliminar las corrientes inducidas, conecte el agua de la piscina a un punto eléctrico de la puesta a tierra
3. Coloque el punto de inyección de producto tras la célula del clorador.

3. CONEXIONES ELÉCTRICAS

Conecte el cable de alimentación a la red eléctrica y el cable previamente conectado del servocontrol al contacto auxiliar de la caja del filtro (230 Vca).



Diagrama de cableado:

1. Entrada de la sonda de nivel (depósito de producto)
- 2.
3. Puerto Serial RS485 (conexión a la automatización de piscinas Fluidra Connect, opcional)
- 4.
5. Salida relé de bomba auxiliar (contacto seco, relé 250 Vca 10 A)
6. Salida relé de alarma remota (contacto seco, relé 250 Vca 10 A)

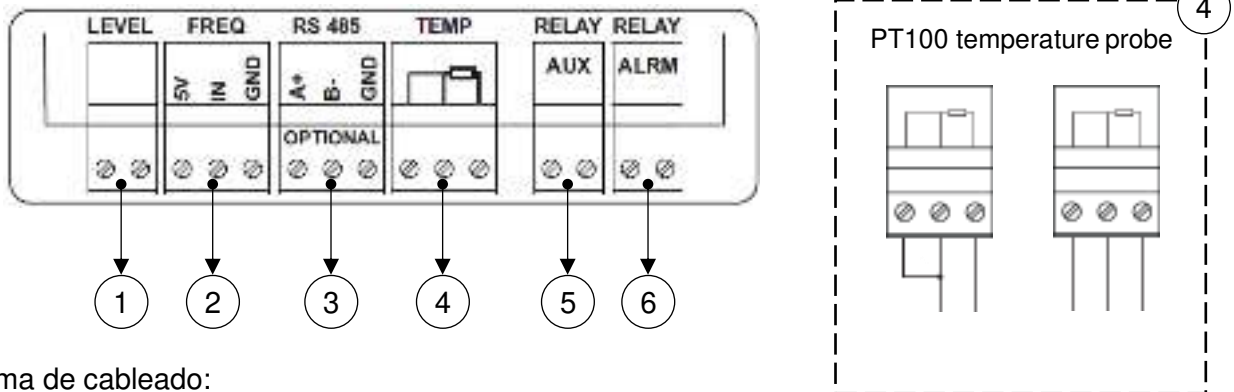
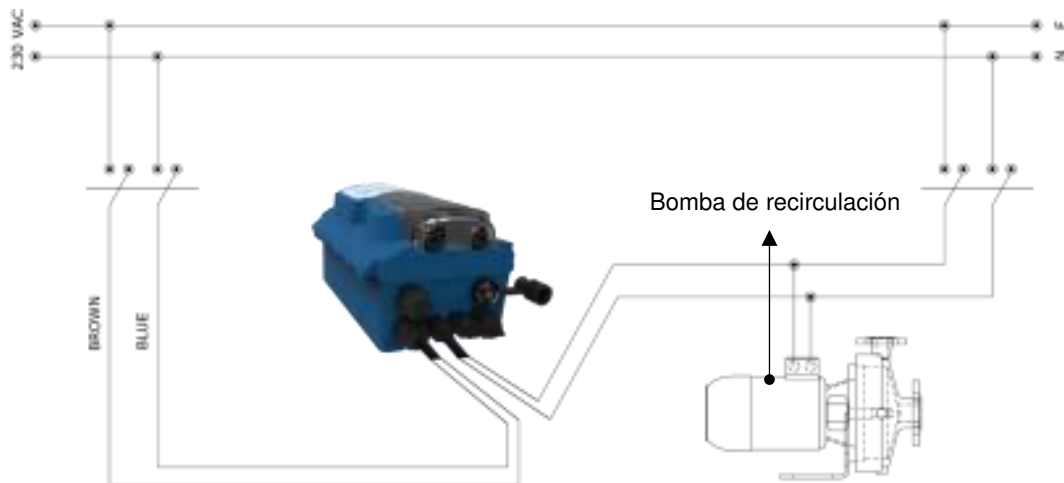

4. ESPECIFICACIONES TÉCNICAS

| Especificaciones | pH PoolMatch | ORP PoolMatch |
|--------------------------------|---------------------------|---------------|
| Intervalo | 3,0 ÷ 10,0 pH | 200 ÷ 999 mV |
| Intervalo | 6,0 ÷ 8,0 pH | 400 ÷ 850 mV |
| | 5,0 ÷ 9,0 pH | 300 ÷ 900 mV |
| Fiabilidad | ± 0,04 pH | ± 2 mV |
| Precisión del dispositivo | 0,1 pH | 1 mV |
| Fuente de alimentación | 230 VAC 50 Hz | |
| Aislamiento clase | II | |
| Consumo | 10 W | |
| Caudal de la bomba | 1,6 l/h | |
| Contrapresión máx. | 1,5 bares | |
| Calibración de la sonda | Automática | |
| Estado de la bomba | Dosificación proporcional | |
| Tubo peristáltico (DI x DE mm) | Norprene 4,8 x 8 mm | |
| Dimensiones (H x L x A): | 185 x 124 x 110 mm | |
| Peso | 1,0 kg | |

5. INSTRUCCIONES DE CONFIGURACIÓN DEL SISTEMA POOLMATCH

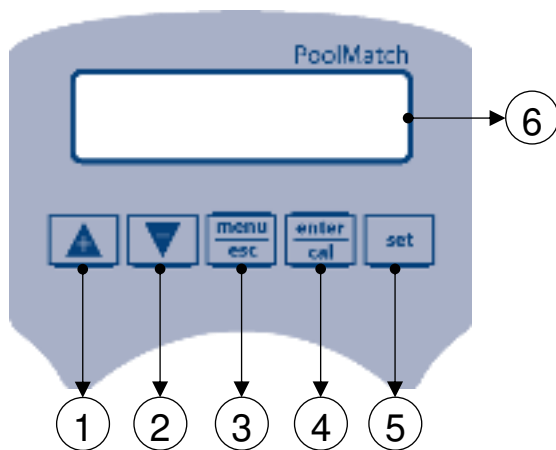

- 1) Botón para aumentar el valor
- 2) Botón para reducir el valor
- 3) Botón Menú/Esc
- 4) Botón Cal/OK
- 5) Botón para configurar el punto de ajuste
- 6) Pantalla digital

Configuración del programa – Pulse **menu/esc** durante 5 segundos

En la entrada de cada elemento del menú, el parámetro puede ser modificado directamente utilizando las teclas de flecha (**▲** y **▼**).

Para confirmar el ajuste actual y pasar al siguiente elemento, pulse el botón **enter/cal**.

El menú tiene una estructura circular: una vez en el último elemento, la confirmación del parámetro configurado se realiza pulsando **enter/cal**, y provoca el regreso al primer elemento del menú.

- 1 LANGUAGE (IDIOMA) – Se puede seleccionar entre 5 idiomas disponibles: **EN**, FR, IT, DE, ES
- 2 SETPOINT (PUNTO DE AJUSTE)– **7,4 pH** (5-9 pH) / **700 mV** (300-900 mV)
- 3 TIPO_DOSIFICACION – **Ácido** (Ácido/Alka) / **Bajo** (Bajo/Alto)
- 4 TIEMPO_ON= 30 segundos (rango desde 1 a 360 segundos)
- 5 TIEMPO_OFF= 60 segundos (rango desde 1 a 360 segundos)

* Solo dosificación programada

4 MENU AVANZADO



- 4.1 BOMBA DE CIRCULACION – (Activada/desactivada)
- 4.2 COMPENSACION DE TEMPERATURA – (Aut./Manual 25°C)
- 4.3 OFR_OFF – (0-60 min)
- 4.4 RS485

Este menú solo está disponible para modelos que disponen del conector Modbus RS485



- Velocidad en baudios (2400, 4800, 9600 o 19200)
 - Polaridad (par, impar o ninguna)
 - Dirección (de 1 a 240)
 - Controlador RS485 (apagado, 1-30000 segundos)
 - Configuración del Controlador (reinicio del hardware, alarma del controlador, detención de la dosificación, restablecimiento de la comunicación)
- 4.5 CAUDAL DE ENTRADA
 - Impulso/litro 1:1
 - Medida de unidad m³, l.
 - 4.6 CALIBRACION
 - Dos puntos
 - Un punto
 - Referencia
 - 4.7 DOSIFICACION DE LA BOMBA PERISTALTICA
 - On/Off
 - Programada
 - Proporcional
 - Apagada

PoolMatch | pH · ORP





Guardar y salir de la configuración del programa – Pulse 

Al pulsar la tecla  se sale del menú de programación y se guardan los parámetros si el parámetro del elemento del menú en el que se encuentra no ha cambiado al pulsar la tecla .



Configuración del punto de ajuste

Pulse el botón  durante 3 segundos, use  y  para ajustar el valor deseado.

Stand-by (Modo suspensión)

Pulse los botones  y  al mismo tiempo durante 5 segundos para apagar la retroiluminación de la unidad. El sistema de dosificación y calibración están deshabilitados. Para salir del modo Stand-by (Suspensión), pulse los botones  y  al mismo tiempo.





Cebado

Mientras la bomba se encuentra en estado de Stand-by (Suspensión) pulse  y  al mismo tiempo.

Reinicio del contador de caudal

Para reiniciar el valor del "Totalizador Permanente", pulse el botón  durante 3 segundos, solo en modo suspensión.

Compensación/Menú de inclinación

Al pulsar los botones  y , la unidad muestra el valor de calibración de la compensación/inclinación. Pulse  o  para desplazarse por el menú.

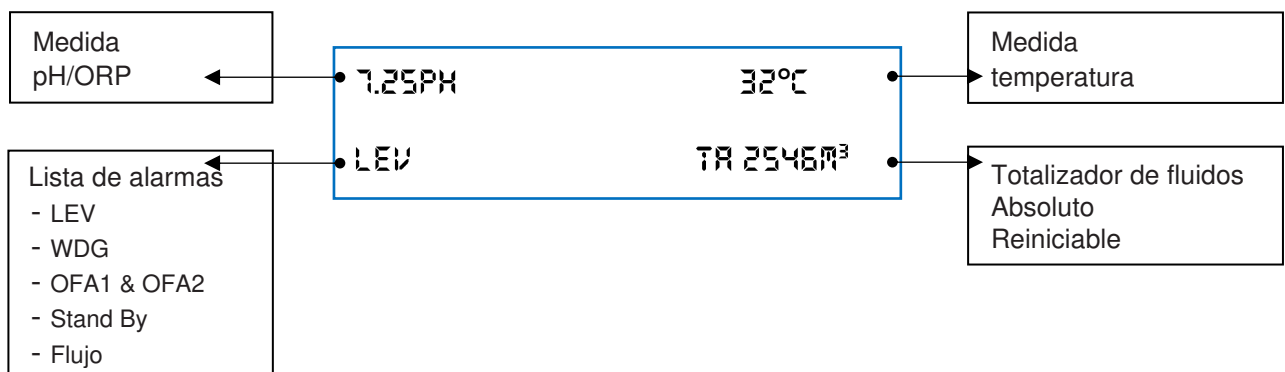

6. CALIBRACIÓN DEL pH

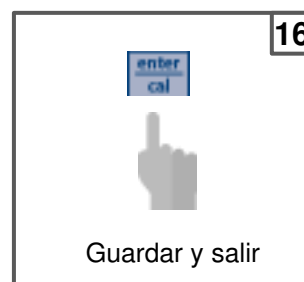
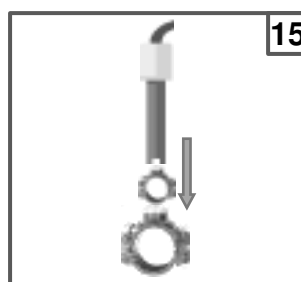
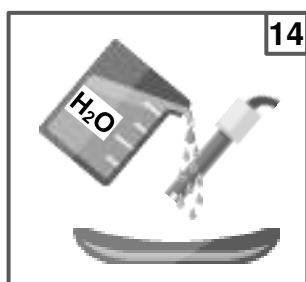
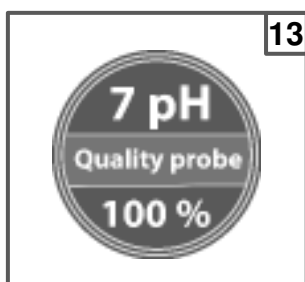
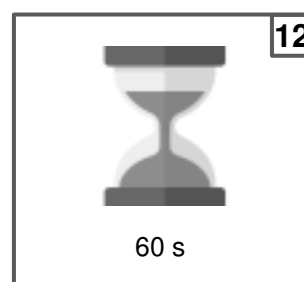
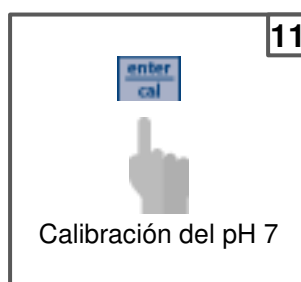
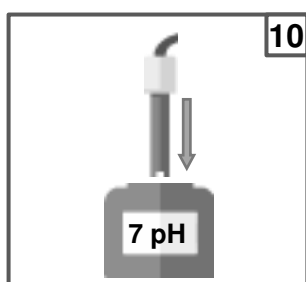
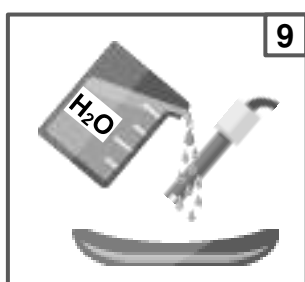
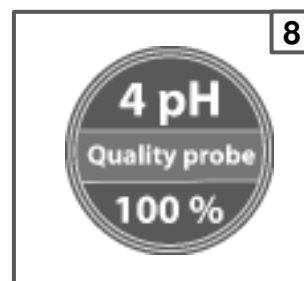
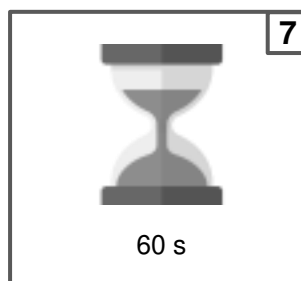
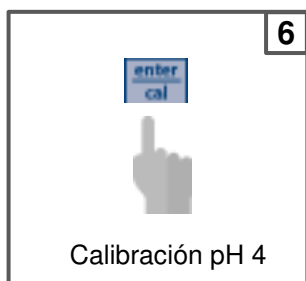
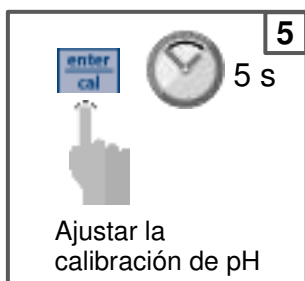
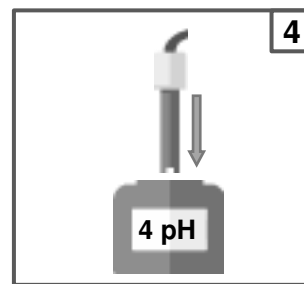
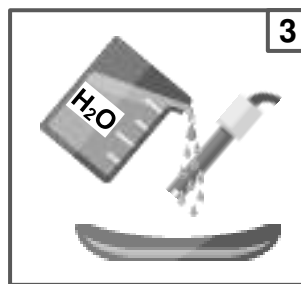
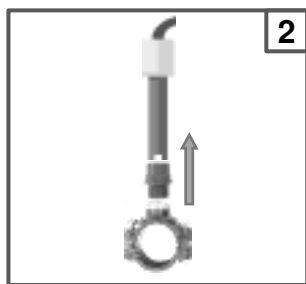
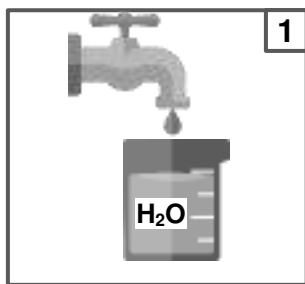

7. CALIBRACIÓN DEL ORP

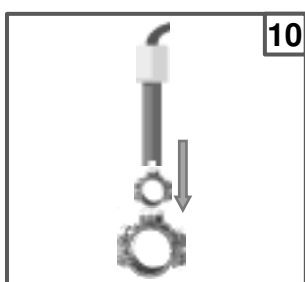
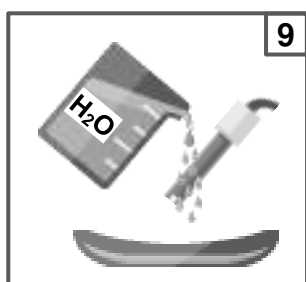
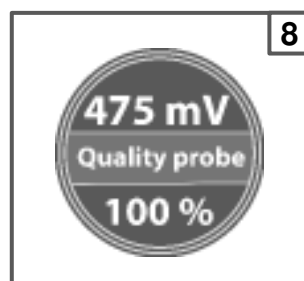
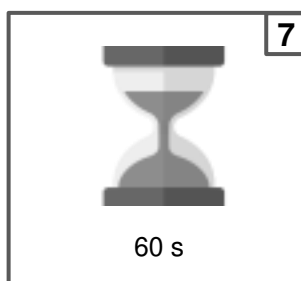
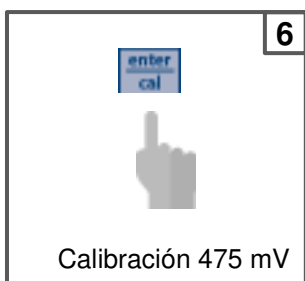
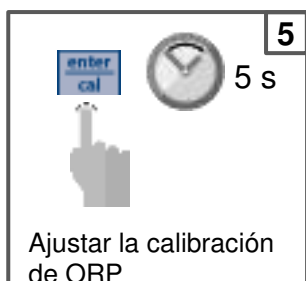
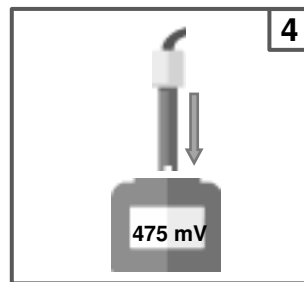
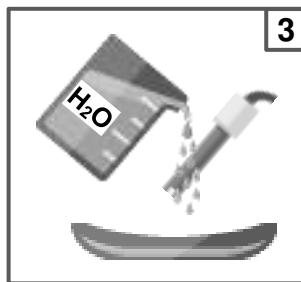
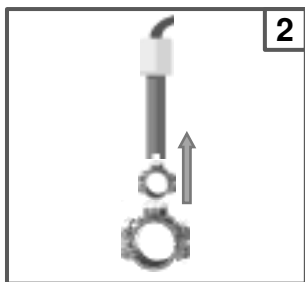
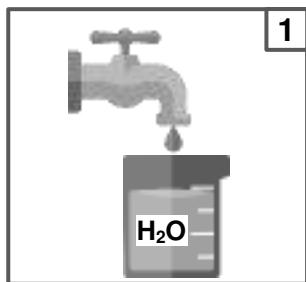

8. DOSIFICACIÓN PROPORCIONAL

Punto de ajuste = 7,4 pH

Modo de dosificación = ácido

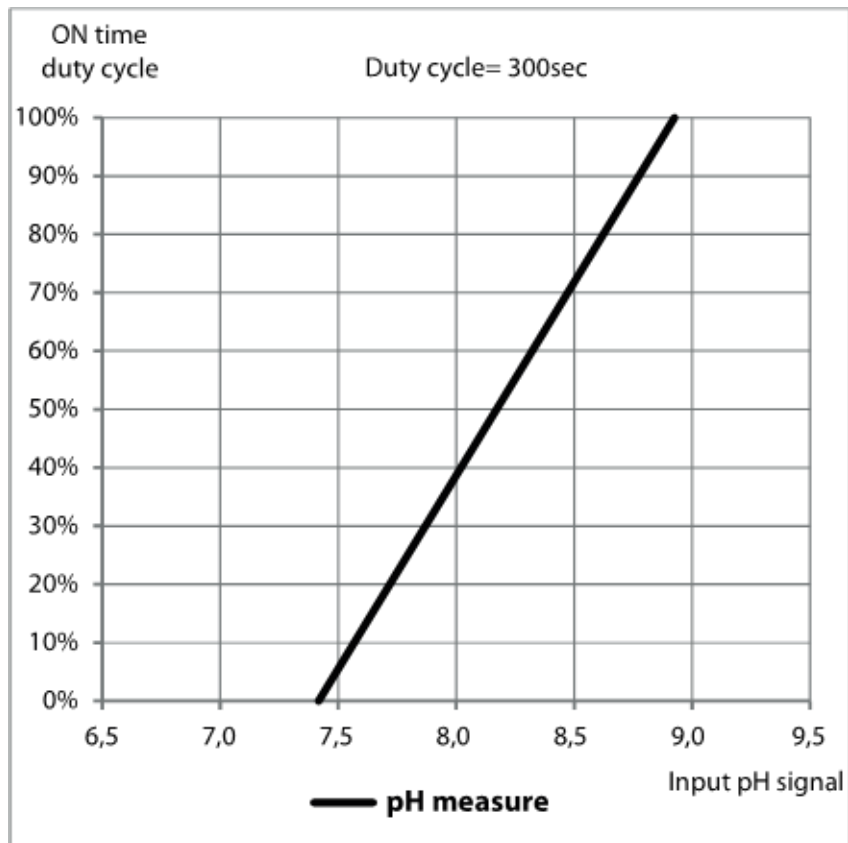



Punto de ajuste = 700 mV

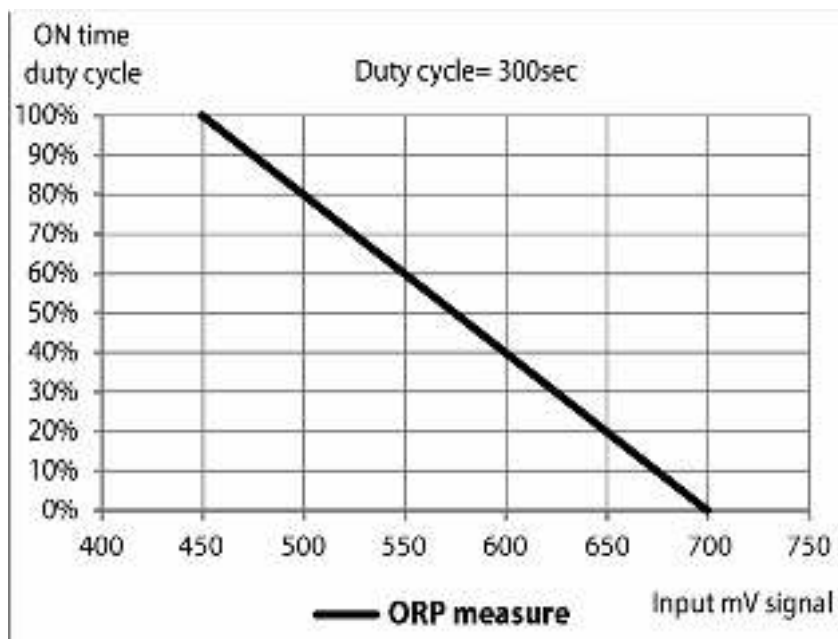



Modo de dosificación = Bajo



9. ALARMAS

| Alarma | Pantalla pH PoolMatch | Pantalla ORP PoolMatch | Acciones que deben realizarse |
|----------------------------------|-------------------------------------------------------|---------------------------|--------------------------------------------------------------------------------------------------------------------------------------------------------|
| Nivel | NIVEL DE DEPOSITO BAJO | - | - Restablezca el depósito de producto |
| Medida fuera de rango | MEDIDA MUY BAJA (<5 pH) MEDIDA MUY ELEVADA (>9 pH) | MEDIDA MUY BAJA (<100 mV) | - Sustituya o compruebe la sonda de medición - Restablezca la medida de pH / ORP |
| Alarma OFA (tiempo > tiempo OFA) | OFA | - | - Pulse  para reiniciar |
| Caudal | FILTRACION APAGADA | - | - Restablezca el caudal |
| Función de calibración | ERROR_____7_PH ERROR_____4_PH CALIBRAC._____PH7 | ERROR_____700_mV | - Restaure la sonda o la solución tampón y repita el procedimiento de calibración |
| Error del sistema | ERROR DE PARAMETROS | | - Pulse  para restablecer el parámetro por defecto - Unidad rota |
| Error Modbus | CONTR. | | - Pulse  para reiniciar - Restablezca la comunicación |

Para restaurar los parámetros por defecto, siga los siguientes pasos:

- Apague la unidad PoolMatch
- Mantenga  y  pulsados y encienda la unidad
- La unidad parpadeará INIT.DEFAULT__NO
- Pulse  INIT.DEFAULT__YES
- Pulse  para restablecer los parámetros por defecto

| Parámetros por defecto | pH PoolMatch | ORP PoolMatch |
|---------------------------|------------------------|---------------|
| Idioma | EN | |
| Tiempo OFA | OFF | |
| Entrada de flujo | OFF | |
| Valor del punto de ajuste | 7,4 = pH | 700 mV |
| Calibración | 7 pH / 4 pH (2-puntos) | 475 mV |
| Método de dosificación | Ácido | Bajo |

10. MANIPULACIÓN

Sustitución de la manguera:



Abra la tapa de la bomba y suelte la manguera tirando del conector izquierdo hacia arriba.



Coloque el rollo a las 7h 05, girándolo en la dirección de la flecha circular.



Suelte por completo el conector izquierdo, manteniéndola tensa hacia fuera, y gire el rollo en la dirección de la flecha circular para que la manguera quede liberada hasta el conector derecho.



Coloque el rollo a las 7h 05 girándolo en la dirección de la flecha circular.



Introduzca el conector izquierdo en el compartimento correspondiente y pase la manguera por debajo de la guía del rollo. Gire el rollo en la dirección de la flecha circular, acompañando al mismo tiempo la manguera dentro del cabezal de la bomba hasta alcanzar el conector derecho.



Cierre la tapa de la bomba y presione la superficie fuertemente para que quede correctamente encajada en su sitio.



MISE EN GARDE !

Avant TOUTE intervention à l'intérieur du panneau de commande de l'appareil PoolMatch, s'assurer de le débrancher de l'alimentation électrique.

Le non-respect des instructions contenues dans ce manuel peut entraîner des blessures aux personnes et/ou endommager l'appareil et le système.

1. CONTENU DE L'EMBALLAGE

| | | | | |
|---------------------------------------------------------------------------------------|-------------------------------------------------------------------------------------|-------------------------------------------------------------------------------------|---------------------------------------------------------------------------------------|---------------------------------------------------------------------------------------|
|  |  |  |  |  |
| A: Sellette de raccordement pour la fixation de PSS3 sur le tuyau 2" (φ=50 mm) | B: Filtre au pied (Rehausse PP) | C: Kit support de montage (φ=vis de 6 mm) | D: Vanne à lèvres FPM (3/8" GAS) | E: Porte-sonde PSS3 (1/2" GAS) |
|  |  |  |  |  |
| F: Sonde pH | G: Sonde Redox | H: Solution tampon pH 7 | I: Solution tampon pH 4 | J: Solution d'étalonnage 475 mV |
|  |  |  |  | |
| K: Eau | L: Tube de PVC 4x6 (IDxOD mm) (4m) | M: Tube de PE 4x6 (IDxOD mm) (5m) | N: Réducteur pour soupape d'injection (1/2" M vers 3/8" F) | |

| Élément* | A | B | C | D | E | F | G | H | I | J | K | L | M | N |
|----------------------|---|---|---|---|---|---|---|---|---|---|---|---|---|---|
| Système | | | | | | | | | | | | | | |
| PoolMatch pH | 2 | 1 | 1 | 1 | 1 | 1 | - | 1 | 1 | - | 1 | 1 | 1 | 1 |
| PoolMatch ORP | 2 | 1 | 1 | 1 | 1 | - | 1 | - | - | 1 | 1 | 1 | 1 | 1 |

* Les valeurs du tableau représentent le nombre d'éléments contenus à l'intérieur du paquet.

PoolMatch | pH · ORP

MISE EN GARDE !

Ces produits sont **DANGEREUX** et requièrent des précautions particulières lors de leur utilisation, leur manipulation et leur stockage.

- **NE JAMAIS mélanger les produits chimiques.**
- **NE JAMAIS** laisser des enfants ou des personnes qui n'ont pas lu ce manuel, utiliser ou manipuler PoolMatch ou l'un de ses composants périphériques (y compris les produits chimiques).

Produits chimiques concernant le pH :

- **ABSOLUMENT** non recommandé => acide sulfurique pur
- Recommandé pour abaisser le pH => pH négatif (avec une base d'acide sulfurique)
- Recommandé pour élever le pH => pH positif (carbonate ou bicarbonate de sodium)

Produits chimiques concernant l'ORP

- **ABSOLUMENT** non recommandé => tous les types de chlore organique

Les sondes pH/ORP sont sujettes à l'usure et ne sont donc pas couvertes par la garantie.

2. INSTRUCTIONS D'INSTALLATION

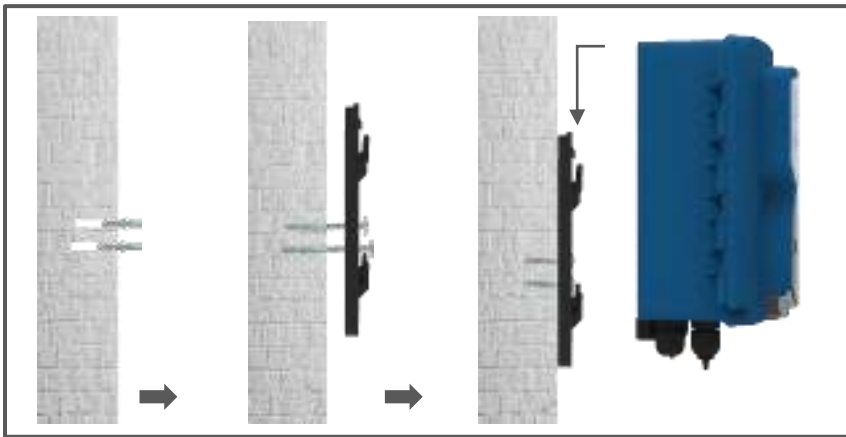

Assurez-vous que la pression d'injection est inférieure à 1,5 bar

Positionnement de la sonde

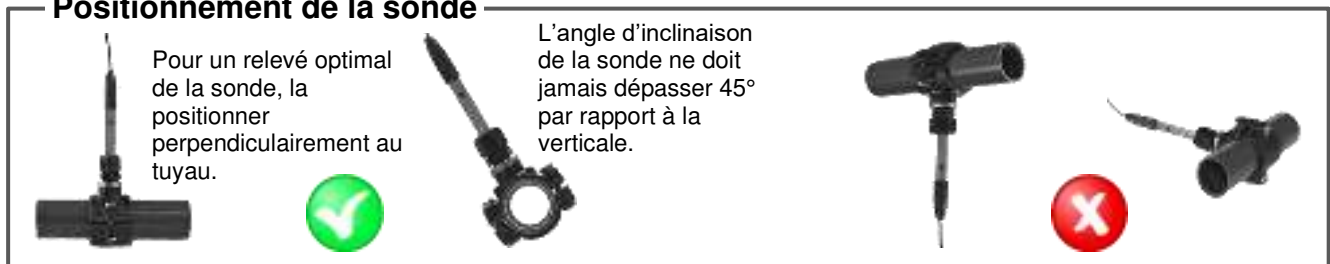

Unité d'installation

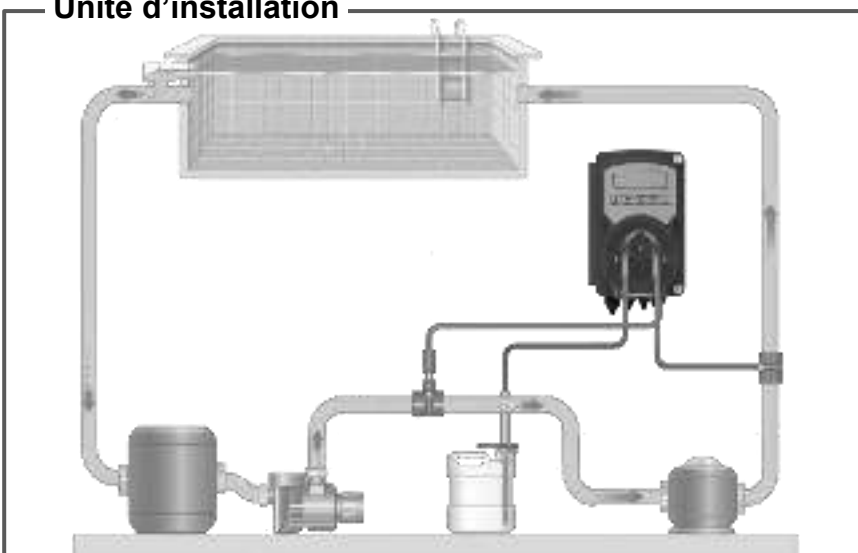

Mise en garde !

Utilisation avec l'électrolyseur au sel :

Pour les systèmes de pH, pour éviter le risque de dysfonctionnement ou d'endommagement, respecter les instructions suivantes :

1. Placer la sonde de mesure du pH en amont de la cellule de l'électrolyseur.
2. Pour éliminer les courants de Foucault, brancher l'eau de la piscine sur un point de masse électrique.
3. Placer le point d'injection du produit en aval de la cellule de l'électrolyseur.

3. RACCORDEMENTS ELECTRIQUES

Brancher l'alimentation électrique sur le secteur et le câble pré-câblé de servocommande au contact auxiliaire du boîtier de filtre (230 Vca).



Schéma de câblage :

1. Entrée sonde de niveau (réservoir de produit)
- 2.
3. Port série RS485 (connexion à l'automatisation de piscine Fluidra Connect, en option)
- 4.
5. Sortie Relais pompe à distance (contact sec, relais 250 Vca 10 A)
6. Sortie Relais alarme à distance (contact sec, relais 250 Vca 10 A)

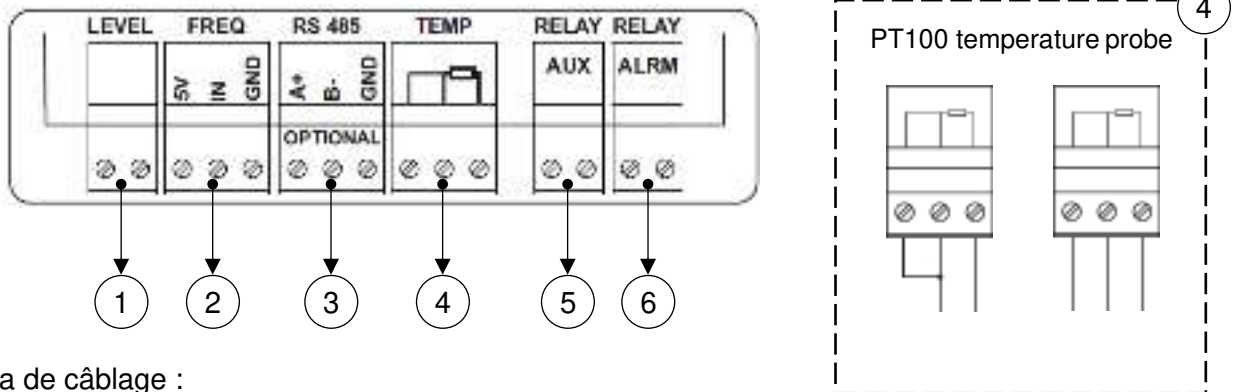
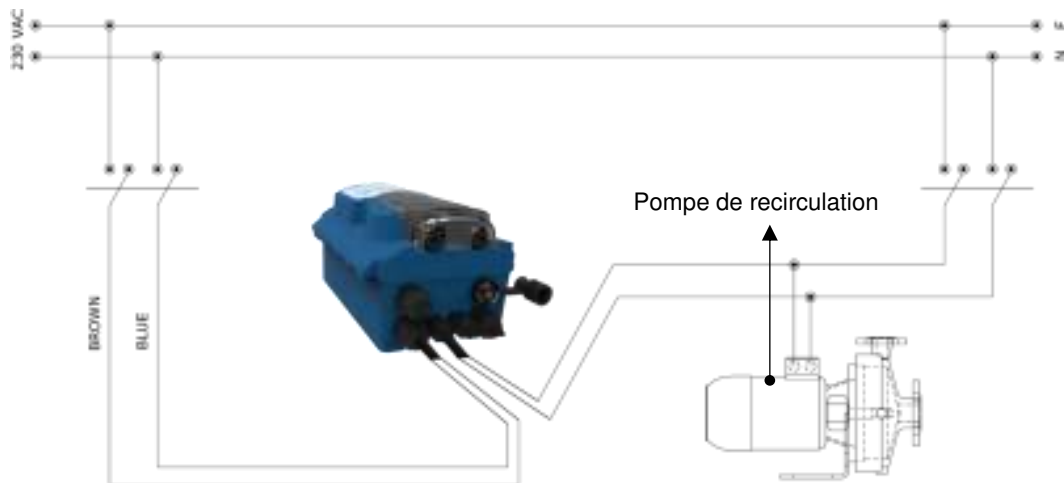

4. SPECIFICATIONS TECHNIQUES

| Spécifications | PoolMatch pH | PoolMatch ORP |
|----------------------------------|----------------------|---------------|
| Plage de mesure | 3,0 ÷ 10,0 pH | 200 ÷ 999 mV |
| Plage de point de consigne | 6,0 ÷ 8,0 pH | 400 ÷ 850 mV |
| | 5,0 ÷ 9,0 pH | 300 ÷ 900 mV |
| Précision | ± 0,04 pH | ± 2 mV |
| Précision de l'appareil | 0,1 pH | 1 mV |
| Alimentation électrique | 230 VCA 50 Hz | |
| Classe d'isolation | II | |
| Consommation | 10 W | |
| Débit pompe | 1,6 l/h | |
| Contre-pression max. | 1,5 bar | |
| Étalonnage de sonde | Automatique | |
| État de la pompe | Dosage proportionnel | |
| Tuyau péristaltique (ID x OD mm) | Norprène 4,8 x 8 mm | |
| Dimensions (H x W x D mm) | 185 x 124 x 110 mm | |
| Poids | 1,0 kg | |

5. INSTRUCTIONS DE CONFIGURATION SYSTEME POOLMATCH

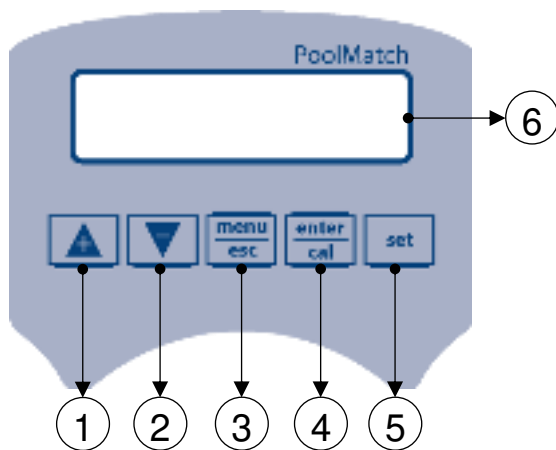

- 1) Bouton pour augmenter la valeur
- 2) Bouton pour diminuer la valeur
- 3) Bouton Menu/Échap
- 4) Bouton Étal/OK
- 5) Bouton pour configurer le point de consigne
- 6) Écran numérique

Configuration du programme – Appuyer sur **menu/esc** pendant 5 secondes

À l'entrée de chaque élément de menu, le paramètre peut être modifié directement à l'aide des touches fléchées (**▲** et **▼**).

Appuyer sur le bouton **enter/cal** pour confirmer le réglage actuel et passer au prochain élément.

Le menu a une structure circulaire : une fois arrivé au dernier élément, la confirmation du jeu de paramètres, en appuyant sur **enter/cal**, détermine le retour au premier élément de menu.

- 1 LANGUE – Il est possible de choisir parmi 5 langues disponibles : **EN**, FR, IT, DE, ES
- 2 POINT DE CONSIGNE – **7,4 pH** (5-9 pH) / **700 mV** (300-900 mV)
- 3 TYPE_DOSAGE – **Acide** (Acid/Alka) / **Bas** (Bas/Haut)
- 4 TIME_ON = 30 secondes (plage de 1 à 360 secondes)
- 5 TIME_OFF = 60 secondes (plage de 1 à 360 secondes)

* Dosage temporisé uniquement

4 MENU AVANCE

- 4.1 POMPE DE RECIRCULATION – (Activée/Désactivée)
- 4.2 TEMP. COMPENSATION – (Auto/Manuel 25 °C)
- 4.3 OFR_OFF – (0-60 min)
- 4.4 RS485

Le menu n'est disponible que dans les modèles qui disposent du connecteur Modbus RS485

- Débit en Bauds (2400, 4800, 9600 ou 19200)
- Polarité (Paire, Impaire ou Aucune)
- Adresse (de 1 à 240)
- Chien de garde RS485 (Off, 1-30000 secondes)
- Config Chien de garde (Réinitialisation Hardware, Alarme Chien de garde, Stop dosage, Réinitialisation Communication)

4.5 DEBIT D'ENTREE

- Impulsions/litre 1:1
- Mesure unité m³, l.

4.6 ETALONNAGE



- Deux points
- Un point
- Référence

4.7 DOSAGE PERISTALTIQUE



- On/Off
- Temporisé
- Prop
- Désactivé

PoolMatch | pH · ORP





Enregistrer et quitter la configuration du programme – Appuyer sur 

Une pression sur la touche  détermine la sortie du menu de programmation avec sauvegarde des paramètres, si le paramètre de l'élément de menu dans lequel on se trouve n'a pas été modifié en appuyant sur la touche .



Réglage du point de consigne

Appuyer sur le bouton  pendant 3 secondes, utiliser  et  pour régler la valeur souhaitée.

Veille

Appuyer simultanément sur les touches  et  pendant 5 secondes pour éteindre le rétroéclairage de l'appareil. Le dosage et l'étalonnage sont désactivés. Pour quitter le mode veille, appuyer simultanément sur les touches  et .





Amorçage

Pendant que la pompe est en veille, appuyer sur la touche  et  dans le même temps.

Réinitialisation du compteur de débit

Pour réinitialiser la valeur du « Totalisateur permanent », appuyer sur la touche  pendant 3 secondes, en mode veille uniquement.

Menu Offset/Pente

Appuyer sur les boutons  et  pour afficher la valeur d'étalonnage Offset/Pente de l'appareil, puis appuyer sur  ou  pour faire défiler le menu.

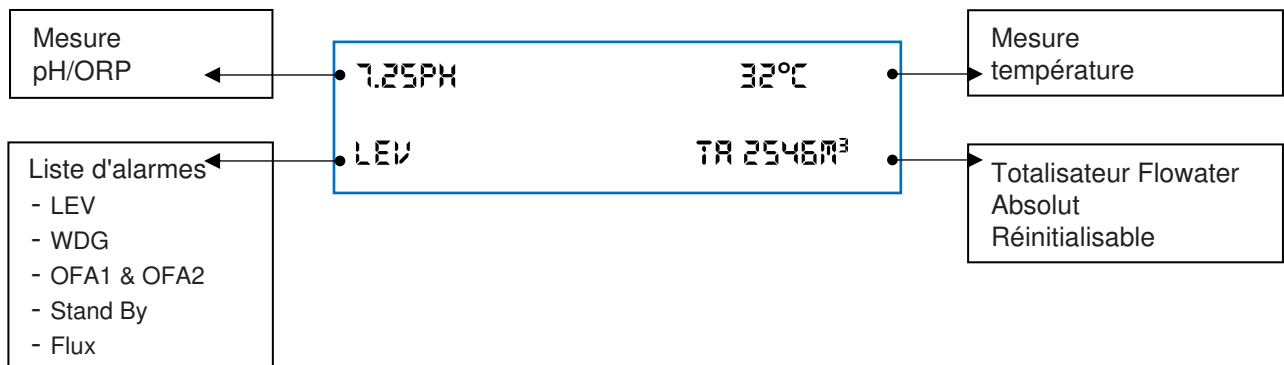

6. ÉTALONNAGE pH

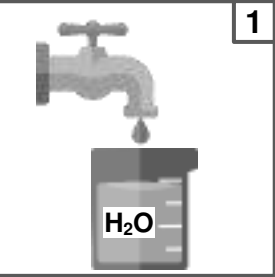
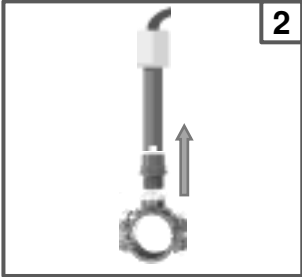
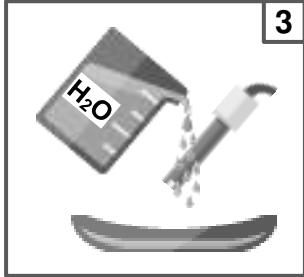
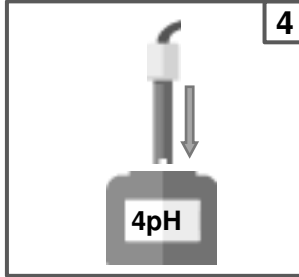
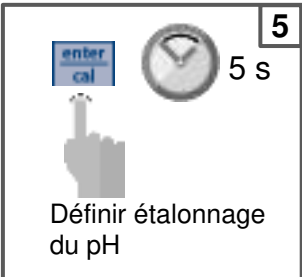
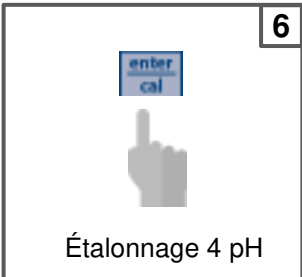
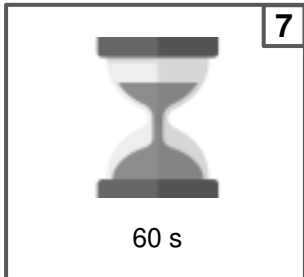
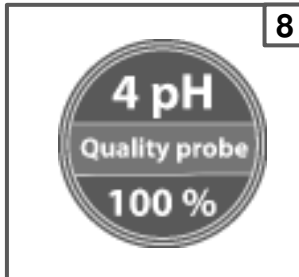
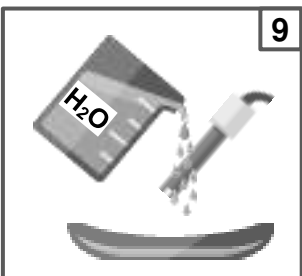
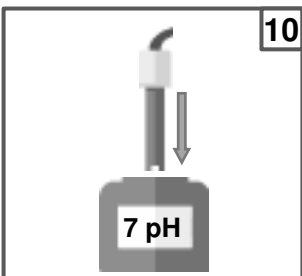
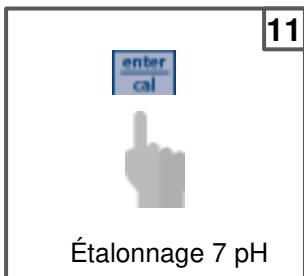
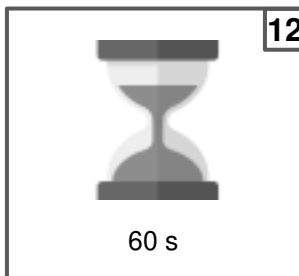
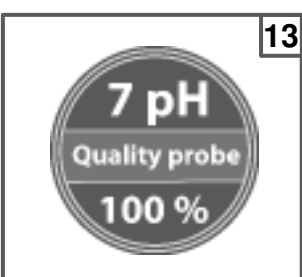
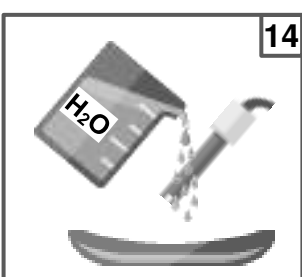
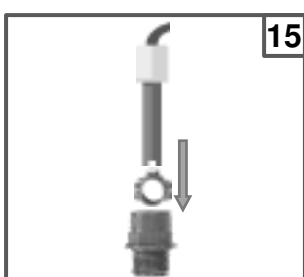
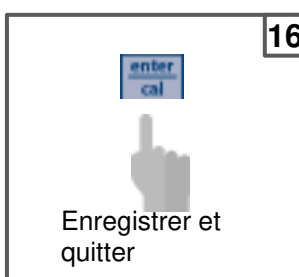
| | | | |
|---------------------------------------------------------------------------------------------------------------------------------------|-------------------------------------------------------------------------------------------------------------------|----------------------------------------------------------------------------------------------------------------------|--------------------------------------------------------------------------------------------------------------------------------------|
|  <p>1</p> |  <p>2</p> |  <p>3</p> |  <p>4</p> |
|  <p>5</p> <p>5 s</p> <p>Définir étalonnage du pH</p> |  <p>6</p> <p>Étalonnage 4 pH</p> |  <p>7</p> <p>60 s</p> |  <p>8</p> <p>4 pH Quality probe 100 %</p> |
|  <p>9</p> |  <p>10</p> <p>7 pH</p> |  <p>11</p> <p>Étalonnage 7 pH</p> |  <p>12</p> <p>60 s</p> |
|  <p>13</p> <p>7 pH Quality probe 100 %</p> |  <p>14</p> |  <p>15</p> |  <p>16</p> <p>Enregistrer et quitter</p> |

7. ÉTALONNAGE ORP

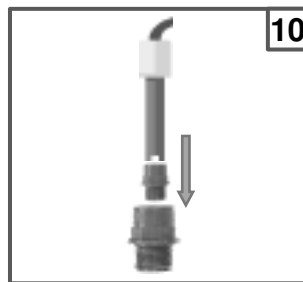
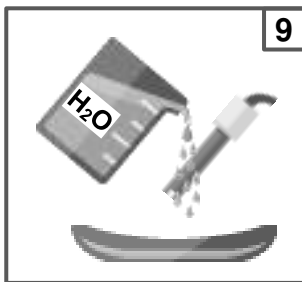
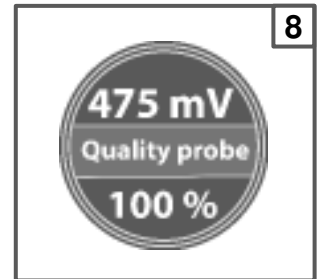
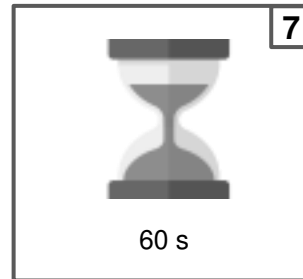
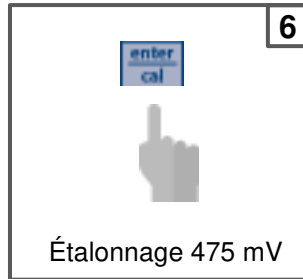
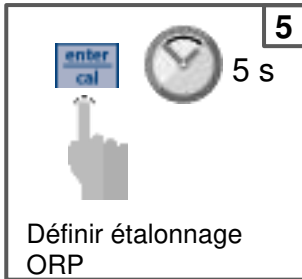
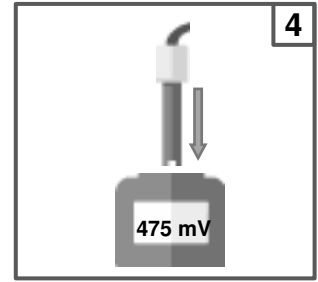
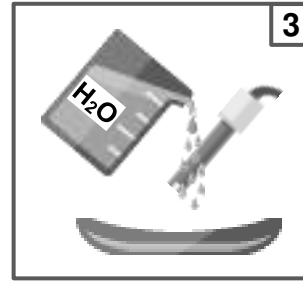
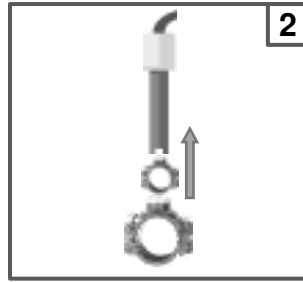
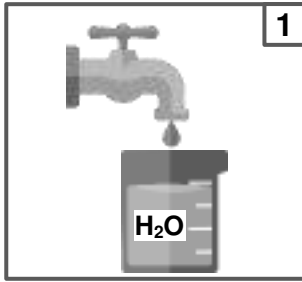

8. DOSAGE PROPORTIONNEL

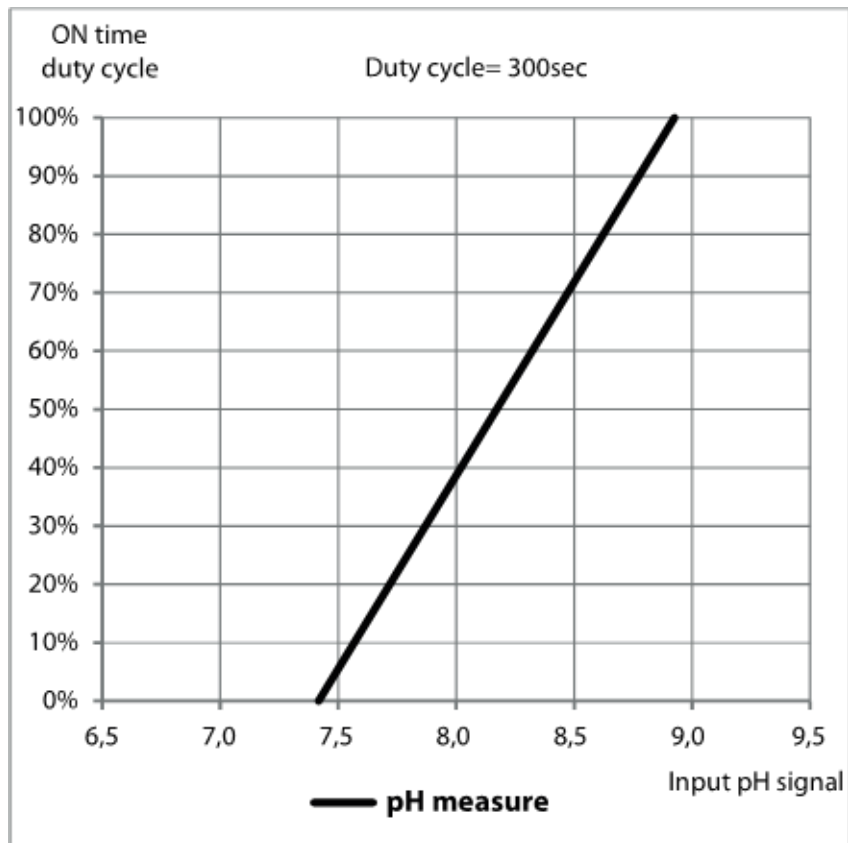

Point de consigne = 7,4 pH
Mode de dosage = Acide



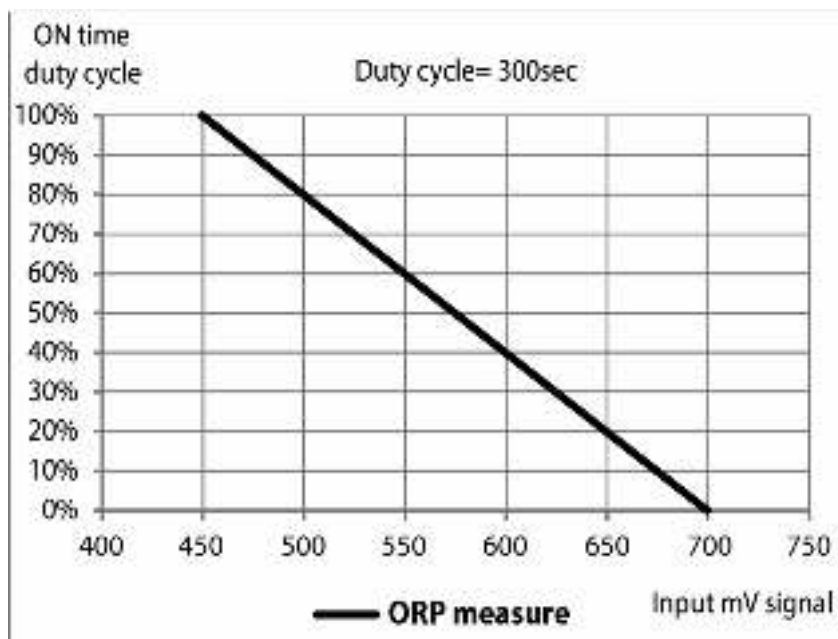



Point de consigne = 700 mV
Mode de dosage = Bas



9. ALARMES

| Alarme | Affichage PoolMatch pH | Affichage PoolMatch ORP | Actions à réaliser |
|--------------------------------|-------------------------------------------------------------|-----------------------------|--------------------------------------------------------------------------------------------------------------------------------------------------------------|
| Niveau | NIVEAU RESERVOIR BAS | - | - Ravitailler le réservoir de produit |
| Mesure hors plage | MESURE TROP BASSE (<5 pH) MESURE TROP ELEVEE (>9 pH) | MESURE TROP BASSE (<100 mV) | - Remplacer ou vérifier la sonde de mesure - Restaurer mesure pH/ORP |
| Alarme OFA (durée > durée OFA) | OFA | - | - Appuyer sur  pour réinitialiser |
| Débit | FILTRATION OFF | - | - Restaurer le débit |
| Fonction d'étalonnage | ERREUR _____ 7_PH ERREUR _____ 4_PH ETALONN _____ PH7 | ERREUR _____ 700_mV | - Restaurer la sonde ou la solution tampon et répéter la procédure d'étalonnage |
| Erreur système | ERREUR DE PARAMETRES | | - Appuyer sur  pour restaurer le paramètre par défaut - Unité en panne |
| Erreur Modbus | MODS | | - Appuyer sur  pour réinitialiser - Restaurer la communication |

Pour restaurer les paramètres par défaut, suivre les étapes ci-dessous :

- Éteindre l'unité PoolMatch
- Maintenir  et  enfoncés et allumer l'unité
- Le message `INIT.DEFAULT__NO` clignote à l'écran
- Appuyer sur  `INIT.DEFAULT__YES`
- Appuyer sur  pour restaurer les paramètres par défaut.

| Paramètres par défaut | PoolMatch pH | PoolMatch ORP |
|-----------------------|------------------------|---------------|
| Langue | EN | |
| Durée OFA | ARRÊT | |
| Admission de débit | ARRÊT | |
| Valeur de consigne | 7,4 pH | 700 mV |
| Étalonnage | 7 pH / 4 pH (2 points) | 475 mV |
| Méthode de dosage | Acide | Bas |

10. MANUTENTION

Remplacement du tuyau :



Ouvrir le couvercle de la pompe et libérer le tuyau en tirant sur le connecteur gauche vers le haut.



Placer le rouleau à 7h05, en le tournant dans le sens de la flèche circulaire.



Libérer complètement le connecteur gauche, en le maintenant tendu vers l'extérieur, et tourner le rouleau dans le sens de la flèche circulaire de sorte que le tuyau soit libéré du connecteur droit.



Placer le rouleau à 7h05, en le tournant dans le sens de la flèche circulaire.



Insérer le connecteur gauche dans le boîtier correspondant et faire passer le tuyau sous le guide du rouleau. Tourner le rouleau dans le sens de la flèche circulaire, en accompagnant simultanément le tuyau dans la tête de la pompe, jusqu'à atteindre le connecteur droit.



Fermer le couvercle de la pompe et appuyer fermement sur sa surface pour qu'elle soit correctement verrouillée en place.



AVVERTENZA!

Prima di effettuare QUALSIASI operazione all'interno del pannello di controllo del dispositivo PoolMatch, assicurarsi di averlo scollegato dalla rete di alimentazione.

Il mancato rispetto delle istruzioni contenute nel presente manuale può causare lesioni a persone e/o danni al dispositivo e al sistema.

1. CONTENUTO DELLA CONFEZIONE

| | | | | |
|--------------------------------------------------------------------------------------------------------------------------------------------------------|----------------------------------------------------------------------------------------------------------------------------------|-----------------------------------------------------------------------------------------------------------------------------------------|---------------------------------------------------------------------------------------------------------------------------------------------------------|------------------------------------------------------------------------------------------------------------------------------------|
|  A: Staffa per fissaggio del PSS3 sul tubo da 2" (φ=50 mm) |  B: Filtro di fondo (montante in PP) |  C: Kit staffe di montaggio (ϕviti da 6 mm) |  D: Valvola a labbro FPM (3/8" GAS) |  E: Porta sonda PSS3 (1/2" GAS) |
|  F: Sonda pH |  G: Sonda Redox |  H: Soluzione tampone pH 7 |  I: Soluzione tampone pH 4 |  J: Soluzione di calibrazione 475mV |
|  K: Acqua |  L: Tubo PVC 4x6 (IDxOD mm) (4m) |  M: Tubo PE 4x6 (IDxOD mm) (5m) |  N: Riduttore per valvola di iniezione (1/2" M - 3/8" F) | |

| Componente* | A | B | C | D | E | F | G | H | I | J | K | L | M | N |
|----------------------|---|---|---|---|---|---|---|---|---|---|---|---|---|---|
| Sistema | | | | | | | | | | | | | | |
| PoolMatch pH | 2 | 1 | 1 | 1 | 1 | 1 | - | 1 | 1 | - | 1 | 1 | 1 | 1 |
| PoolMatch ORP | 2 | 1 | 1 | 1 | 1 | - | 1 | - | - | 1 | 1 | 1 | 1 | 1 |

* I valori riportati nella tabella rappresentano il numero di componenti contenuti nella confezione.

PoolMatch | pH · ORP

AVVERTENZA!

Questi prodotti sono **PERICOLOSI** e richiedono precauzioni speciali durante l'uso, la manipolazione e lo stoccaggio.

- **Non miscelare MAI i prodotti chimici.**
- Non permettere MAI a bambini o a persone che non abbiano letto il presente manuale di utilizzare o manomettere PoolMatch o i suoi componenti periferici (inclusi i prodotti chimici).

Prodotti chimici pH:

- **ASSOLUTAMENTE** sconsigliato => acido solforico puro
- Consigliato per abbassare il pH => pH negativo (con una base di acido solforico)
- Consigliato per aumentare il pH => pH positivo (carbonato o bicarbonato di sodio)

Prodotti chimici ORP:

- **ASSOLUTAMENTE** sconsigliato => tutti i tipi di cloro organico

Le sonde pH / ORP sono soggette a usura e pertanto non sono coperte dalla garanzia.

2. ISTRUZIONI PER L'INSTALLAZIONE

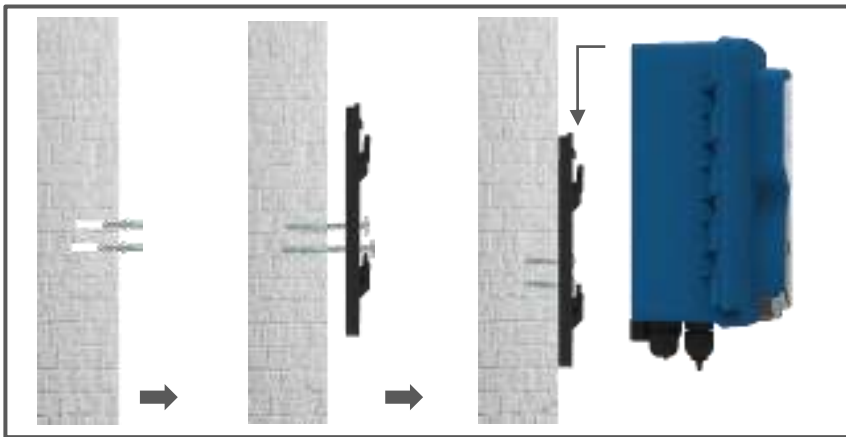

Verificare che la pressione di iniezione sia inferiore a 1,5 bar

Posizionamento della sonda

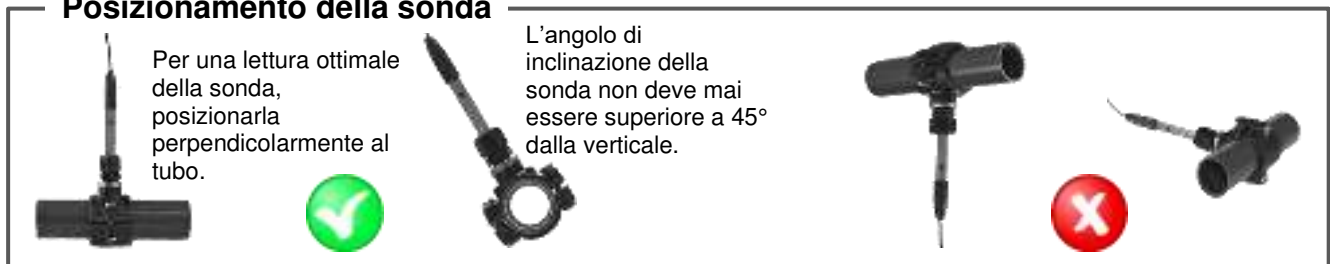

Impianto di installazione

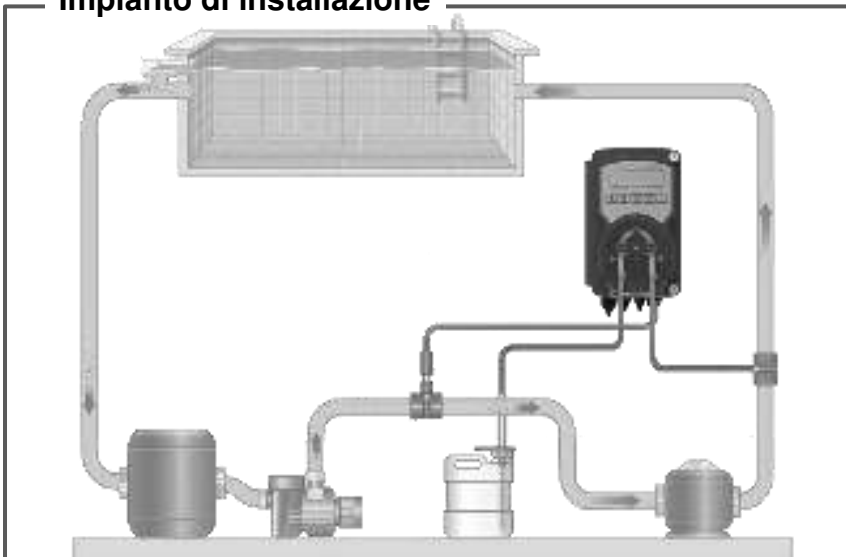

Avvertenza!

Usare con generatore di cloro a sale:

Per evitare rischi di malfunzionamento o danneggiamento dei sistemi pH, rispettare le istruzioni riportate di seguito:

1. Posizionare la sonda di misurazione del pH prima della cella del generatore di cloro.
2. Per eliminare le eventuali correnti parassite, collegare l'acqua della piscina a una massa elettrica.
3. Collocare il punto di iniezione del prodotto dopo la cella del generatore di cloro.

3. COLLEGAMENTI ELETTRICI

Collegare il cavo di alimentazione alla rete di alimentazione elettrica e il cavo pre-cablato del servocomando al contatto ausiliario della scatola dei filtri (230 Vca).

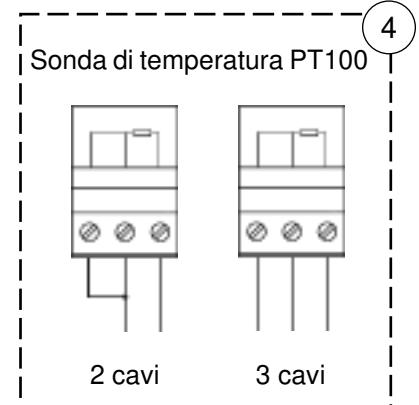
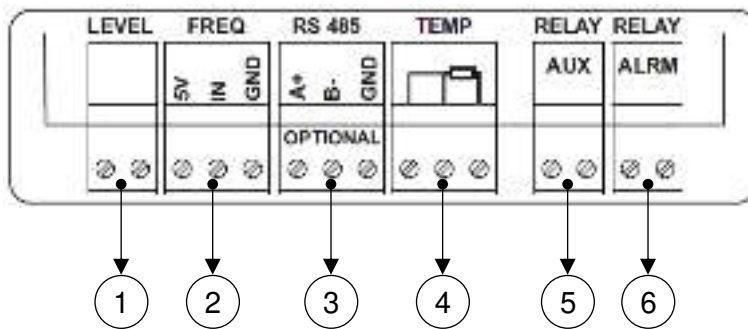

Schema di cablaggio:

1. Ingresso la sonda di livello (serbatoio prodotto)
2. Ingresso segnale di frequenza dal mittente di impulsi contatore dell'acqua
3. Porta seriale RS485 (opzionale)
4. Ingresso sonda di temperatura (Sonda di temperatura PT100 non inclusa)
5. Uscita relè pompa ausiliaria (contatto pulito, relè da 250 Vca 10 A)
6. Uscita allarme relè remoto (contatto pulito, relè da 250 Vca 10 A)

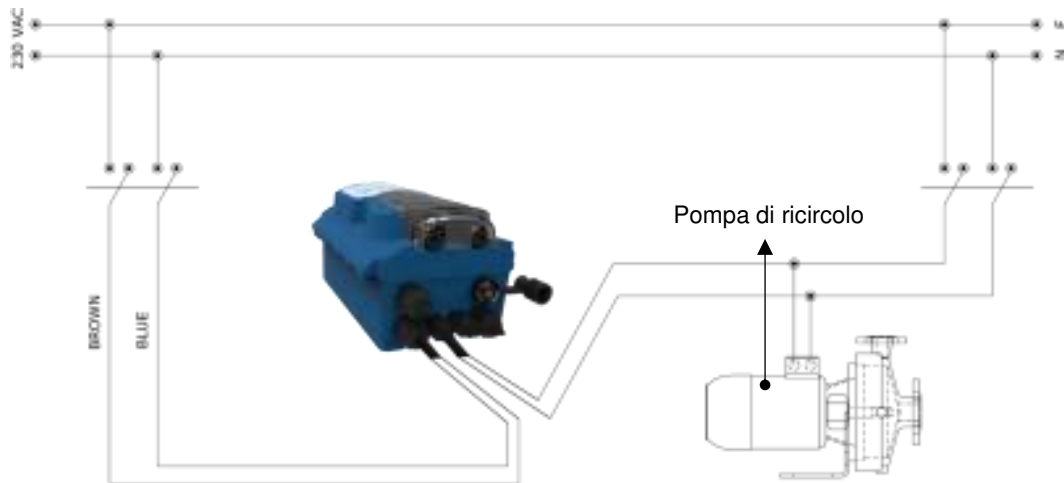

4. SPECIFICHE ELETTRICHE

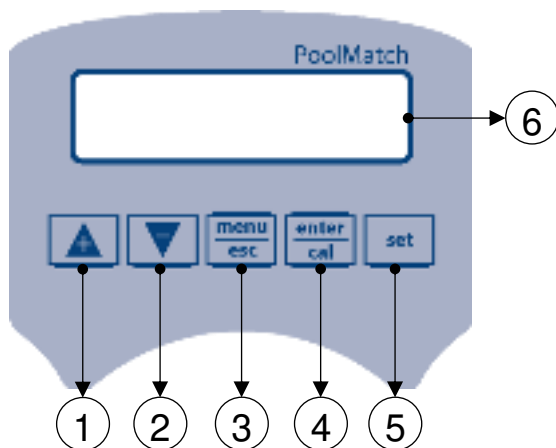

| Specifiche | PoolMatch pH | PoolMatch ORP |
|--------------------------------|------------------------|---------------|
| Intervallo misura | 3,0 ÷ 10,0 pH | 200 ÷ 999 mV |
| Intervallo setpoint | 6,0 ÷ 8,0 pH | 400 ÷ 850 mV |
| Intervallo allarme | 5,0 ÷ 9,0 pH | 300 ÷ 900 mV |
| Precisione | ± 0,04 pH | ± 2 mV |
| Precisione del dispositivo | 0,1 pH | 1 mV |
| Alimentazione | 230 Vca 50 Hz | |
| Classe di isolamento | II | |
| Consumo | 10 W | |
| Portata della pompa | 1,6 l/h | |
| Contropressione max. | 1,5 bar | |
| Calibrazione della sonda | Automatica | |
| Stato pompa | Dosaggio proporzionale | |
| Tubo peristaltico (DI x DE mm) | Norprene 4,8 x 8 mm | |
| Dimensioni (H x W x D mm) | 185 x 124 x 110 mm | |
| Peso | 1,0 kg | |

5. ISTRUZIONI DI CONFIGURAZIONE DEL SISTEMA POOLMATCH



- 1) Pulsante per aumentare il valore
- 2) Pulsante per ridurre il valore
- 3) Pulsante Menu/Esc
- 4) Pulsante Cal/OK
- 5) Pulsante di impostazione del setpoint
- 6) Display digitale

Configurazione del programma - Premere  per 5 secondi

Accedendo ad ogni voce del menu, è possibile modificare direttamente il parametro con i tasti freccia ( e ).

Per confermare dell'impostazione attuale e passare alla voce successiva, premere il tasto .

Il menu è dotato di una struttura circolare: una volta arrivati all'ultima voce, quando si conferma il parametro impostato, premendo  si torna alla prima voce.

1 **LINGUA** - È possibile selezionare tra 5 lingue disponibili: **EN**, FR, IT, DE, ES

2 **SETPOINT** - **7,4 pH** (5-9 pH) / **700 mV** (300-900 mV)

3 **TIPO_DOSAGGIO** - **Acido** (Acido/Alcalino) / **Basso** (Basso/Alto)

* Solo dosaggio temporizzato

4 **TIME_ON** = (Tempo_avvio) 30 secondi (intervallo da 1 a 360 secondi)

5 **TIME_OFF** = (Tempo_arresto) 60 secondi (intervallo da 1 a 360 secondi)

4 MENU AVANZATO

4.1 **POMPA DI RICIRCOLO** - (abilitata/disabilitata)

4.2 **COMPENSAZIONE TEMP.** - (Automatica/Manuale 25°C)

4.3 **OFFA_OFF** - (0-60 min.)

4.4 **RS485**

Questo menu è disponibile solo per modelli dotati del connettore RS485 Modbus

- Baud Rate (2400, 4800, 9600 o 19200)
- Polarità (pari, dispari o nessuna)
- Indirizzo (da 1 a 240)
- RS485 Watchdog (Off, 1-30000 secondi)
- Watchdog Config (Hardware Reset, Watchdog Alarm, Stop Dosing, Reset Communication)

4.5 **PORTATA IN INGRESSO**

- Impulso/litri 1:1
- Unità di misura m³, l.



4.6 **CALIBRAZIONE**

- Due punti
- Punto unico
- Riferimento



4.7 **DOSAGGIO PERISTALTICO**

- On/Off
- A tempo
- Prop
- Off





Salva ed esci dalla configurazione del programma - Premere 

Premendo  si esce dal menu di programmazione salvando i parametri, a condizione che la voce del menu in cui ci si trova non sia stata modificata quando si è premuto il tasto .

Regolazione del setpoint

Tenere il pulsante  premuto per 3 secondi, usare  e  per impostare il valore desiderato.

Modalità Stand-by (retroilluminazione accesa)

Tenere i pulsanti  e  premuti simultaneamente per 5 secondi per disattivare la retroilluminazione dell'unità. Dosaggio e calibrazione sono disattivati. Per uscire dalla modalità di standby, premere simultaneamente i pulsanti  e .





Adescamento

Quando la pompa è in standby, premere contemporaneamente  e .

Reinizializzazione del calcolatore di portata



Per reinizializzare il valore del parametro "Permanent Totalizer" (Totalizzatore fisso) tenere premuto il tasto  per 3 secondi solo in modalità stand-by.

Menu Offset/Slope (Offset/Pendenza)

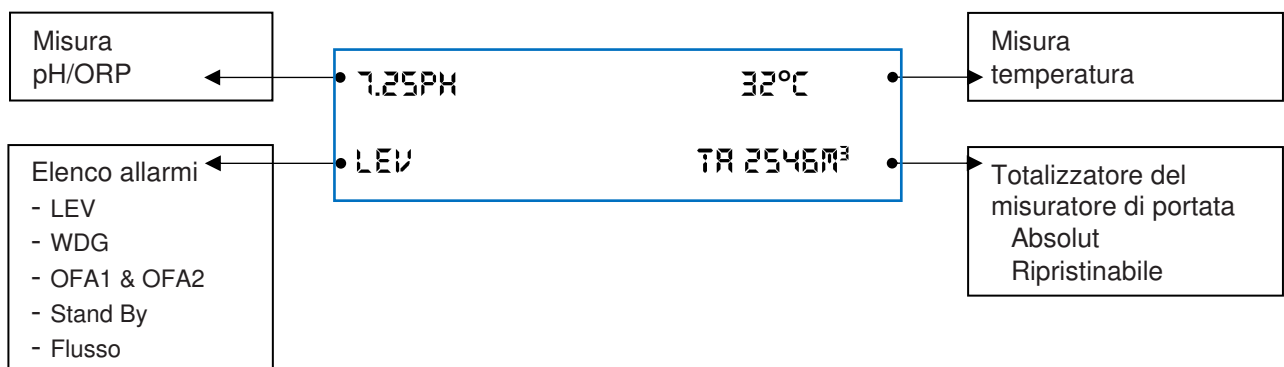
Premere i pulsanti  e  per visualizzare sull'unità i valori di calibratura "Offset/Slope" (Offset/Pendenza); premere  o  per scorrere il menu.

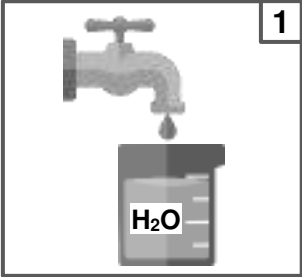
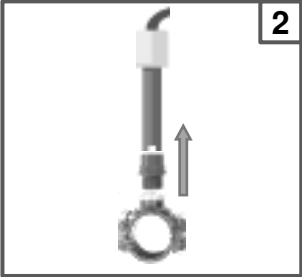
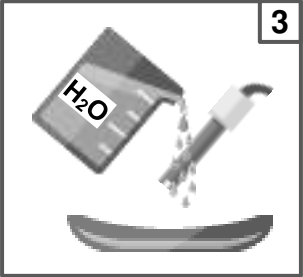
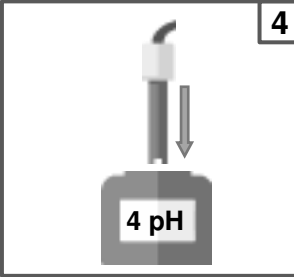
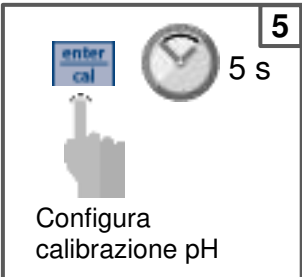
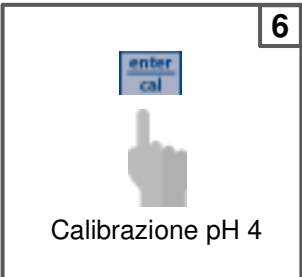
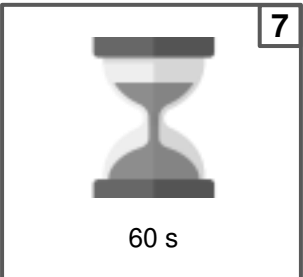
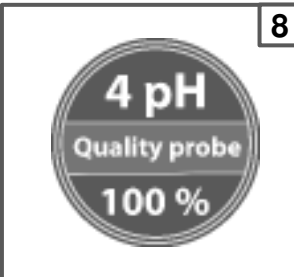
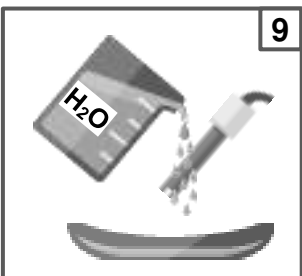
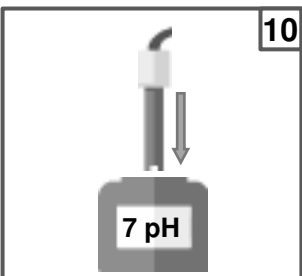
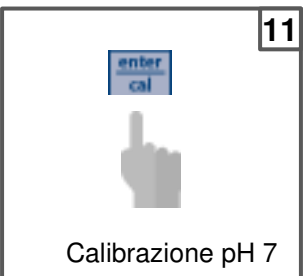
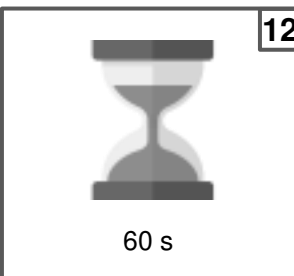

6. CALIBRAZIONE pH

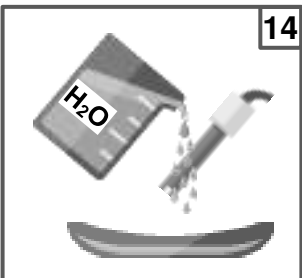
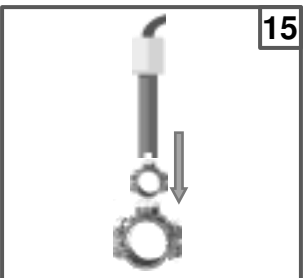
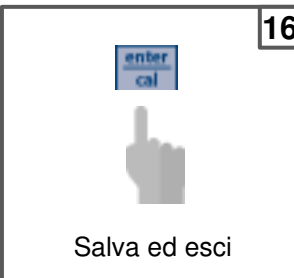
| | | | |
|--------------------------------------------------------------------------------------------------------------------------------------------|---------------------------------------------------------------------------------------------------------------------|------------------------------------------------------------------------------------------------------------------------|--------------------------------------------------------------------------------------------------------------------------------------|
|  <p>1</p> |  <p>2</p> |  <p>3</p> |  <p>4</p> |
|  <p>5</p> <p>5 s</p> <p>Configura calibrazione pH</p> |  <p>6</p> <p>Calibrazione pH 4</p> |  <p>7</p> <p>60 s</p> |  <p>8</p> <p>4 pH Quality probe 100 %</p> |
|  <p>9</p> |  <p>10</p> <p>7 pH</p> |  <p>11</p> <p>Calibrazione pH 7</p> |  <p>12</p> <p>60 s</p> |
|  <p>13</p> <p>7 pH Quality probe 100 %</p> |  <p>14</p> |  <p>15</p> |  <p>16</p> <p>Salva ed esci</p> |

7. CALIBRAZIONE ORP

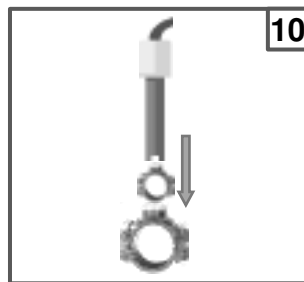
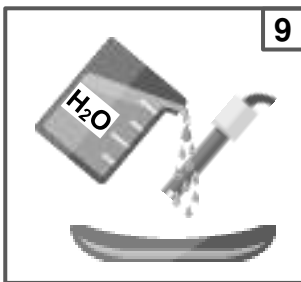
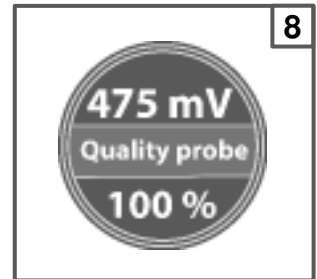
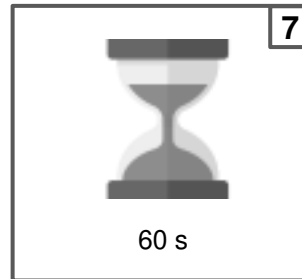
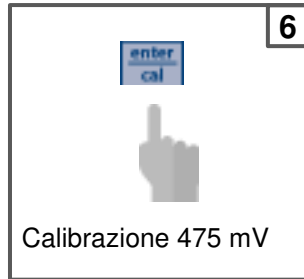
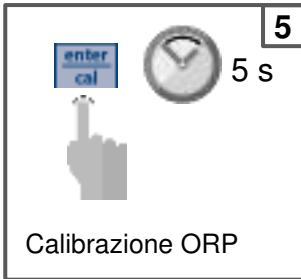
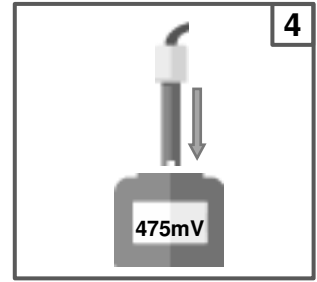
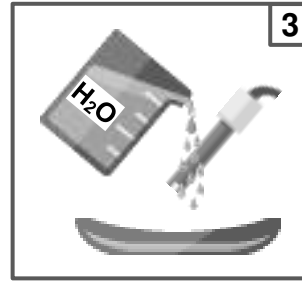
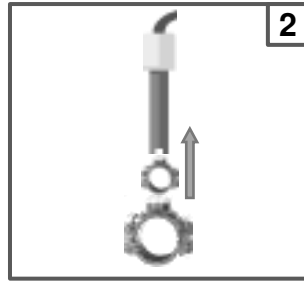
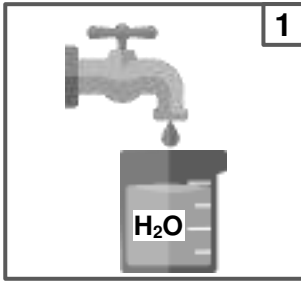

8. DOSAGGIO PROPORZIONALE

Setpoint= 7,4 pH

Modalità di dosaggio = Acido

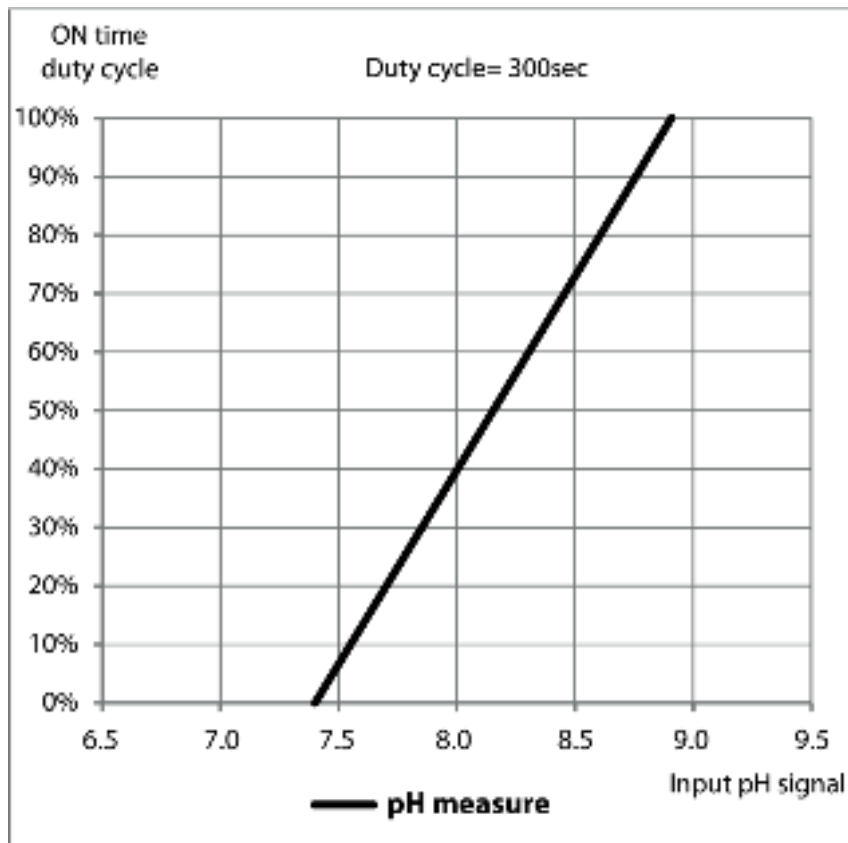



Setpoint = 700 mV

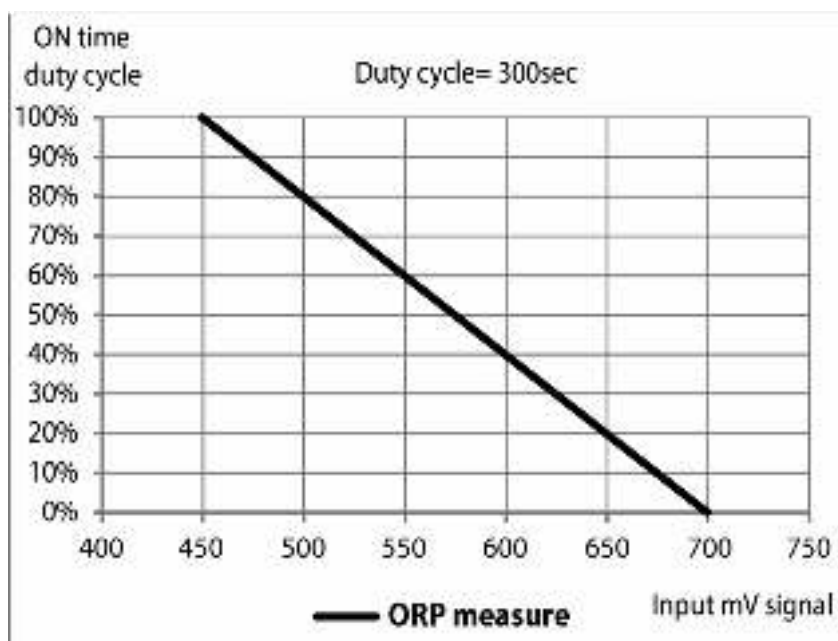



Modalità di dosaggio = Bassa



9. ALLARMI

| Allarme | Display PoolMatch pH | Display PoolMatch ORP | Azioni da eseguire |
|---------------------------------|------------------------------------------------------|---------------------------|---------------------------------------------------------------------------------------------------------------------------------------------------------------|
| Livello | TRNK LEVEL LOW | - | - Ripristinare il serbatoio prodotto |
| Misura fuori intervallo | MEASURE TOO LOW (<5 pH) MEASURE TOO HIGH (>9pH) | MEASURE TOO LOW (<100 mV) | - Sostituire o controllare la sonda di misura - Ripristinare la misura pH / ORP |
| Allarme OFA (tempo > tempo OFA) | OFA | - | - Premere  per azzerare |
| Portata | FILTRATION OFF | - | - Ripristinare la portata |
| Funzione di calibrazione | ERROR_____4_PH ERROR_____7_PH CALIBRAT_____PH7 | ERROR_____700_mV | - Ripristinare la soluzione Sonda o Tampone e ripetere la procedura di calibrazione |
| Errore del sistema | ERRORE DEI PARAMETRI | | - Premere  per ripristinare i parametri predefiniti - Unità danneggiata |
| Errore Modbus | MODS | | - Premere  per azzerare - Ripristinare la comunicazione |

Per ripristinare i parametri predefiniti, procedere come indicato di seguito:

- Spegnerne l'unità PoolMatch
- Tenere  e  premuti e collegare l'unità
- L'unità inizierà a lampeggiare INIT.DEFAULT__NO
- Premere  INIT.DEFAULT__YES
- Premere  per ripristinare i parametri predefiniti.

| Parametri predefiniti | PoolMatch pH | PoolMatch ORP |
|--------------------------------------|-----------------------|---------------|
| Language (Lingua) | EN | |
| Time OFA (Tempo OFA) | OFF | |
| Flow Input (Ingresso flusso) | OFF | |
| Set Point value (Valore di setpoint) | 7,4 pH | 700 mV |
| Calibration (Calibrazione) | pH 7 / pH 4 (2 punti) | 475 mV |
| Dosing Method (Metodo di dosaggio) | Acid (Acido) | Low (Basso) |

10. MOVIMENTAZIONE

Sostituzione dei tubi:



Aprire il coperchio della pompa e rilasciare il tubo tirando il connettore di sinistra verso l'alto.



Posizionare il rullo alle ore 7:05, ruotandolo nella direzione della freccia circolare.



Rilasciare completamente il connettore di sinistra, tenendolo teso verso l'esterno, e ruotare il rullo nella direzione della freccia circolare in modo da liberare il tubo verso il connettore di destra.



Posizionare il rullo alle ore 7:05, ruotandolo nella direzione della freccia circolare.



Inserire il connettore di sinistra nell'apposito alloggiamento e far passare il tubo sotto la guida del rullo. Ruotare il rullo nella direzione della freccia circolare, accompagnando contemporaneamente il tubo nella testata della pompa fino a raggiungere il connettore di destra.



Chiudere il coperchio della pompa e premere sulla superficie in modo da bloccarlo saldamente in posizione.